

SONY

MULTI CHANNEL AV RECEIVER STR-DN1060/STR-DN860

Parts and Controls

Receiver (STR-DN1060)

- [Front panel \(STR-DN1060\) \(upper section\) \[1\]](#)
- [Front panel \(STR-DN1060\) \(lower section\) \[2\]](#)
- [On/standby indicator \(STR-DN1060\) \[3\]](#)
- [Indicators on the display panel \[4\]](#)
- [Rear panel \(STR-DN1060\) \[5\]](#)

Receiver (STR-DN860)

- [Front panel \(STR-DN860\) \(upper section\) \[6\]](#)
- [Front panel \(STR-DN860\) \(lower section\) \[7\]](#)
- [On/standby indicator \(STR-DN860\) \[8\]](#)
- [Indicators on the display panel \[9\]](#)
- [Rear panel \(STR-DN860\) \[10\]](#)

Remote control

- [Remote control \(upper section\) \[11\]](#)
- [Remote control \(lower section\) \[12\]](#)

Preparation

1. Installing speakers

- [Installing 7.1-channel speaker system using surround back speakers \[13\]](#)
- [Installing 7.1-channel speaker system using front high speakers \[14\]](#)
- [Installing 5.1-channel speaker system \[15\]](#)
- [Installing speakers in other rooms \(Zone 2/Zone 3\) \(for STR-DN1060 only\) \[16\]](#)

2. Connecting speakers

- [Connecting speakers \[17\]](#)
- [Connecting the speakers in Zone 2 and/or Zone 3 \(for STR-DN1060 only\) \[18\]](#)
- [Bi-amplifier connections \[19\]](#)

3. Connecting a TV

- [Connecting a TV \(for STR-DN1060\) \[20\]](#)
- [Connecting a TV \(for STR-DN860\) \[21\]](#)
- [Connecting a 4K TV \[22\]](#)
- [Notes on connecting cables \[23\]](#)
- [About HDMI connections \[24\]](#)

4. Connecting audio-visual devices and the antennas (aerials)

- [Connecting devices with HDMI jacks \(for STR-DN1060\) \[25\]](#)
- [Connecting devices with HDMI jacks \(for STR-DN860\) \[26\]](#)
- [Connecting devices with jacks other than HDMI jacks \(for STR-DN1060\) \[27\]](#)
- [Connecting devices with jacks other than HDMI jacks \(for STR-DN860\) \[28\]](#)
- [Connecting an iPhone, iPod, or USB device \[29\]](#)
- [Connecting an MHL-compatible mobile device \[30\]](#)
- [Connecting the antenna \(aerial\) \[31\]](#)
- [Connecting another amplifier in Zone 2 \(for STR-DN1060 only\) \[32\]](#)
- [Connecting another amplifier or TV in the HDMI zone \(for STR-DN1060 only\) \[33\]](#)
- [Digital audio formats supported by the receiver \[34\]](#)
- [Notes on connecting cables \[35\]](#)
- [About HDMI connections \[36\]](#)
- [About MHL \(Mobile High-Definition Link\) connections \[37\]](#)

5. Connecting to the network

- [Connecting the receiver to the network using a LAN cable \(for wired LAN connections only\) \[38\]](#)
- [Connecting the receiver to the network using the wireless LAN antenna \(for wireless LAN](#)

[connections only](#) [39]

6. Turning on the receiver/preparing the remote control

- [Inserting batteries into the remote control](#) [40]
- [Turning on the receiver](#) [41]

7. Setting up the receiver using Easy Setup

- [Setting up the receiver using Easy Setup](#) [42]

Tips for automatic calibration (Auto Calibration)

- [1. About Auto Calibration](#) [43]
- [2. Before you perform Auto Calibration](#) [44]
- [3. Connecting the optimizer microphone](#) [45]
- [4. Selecting the front speakers](#) [46]
- [5. Performing Auto Calibration](#) [47]
- [6. Checking Auto Calibration results](#) [48]

Enjoying Video and Sound

Playing AV devices

- [Enjoying Video and Sound](#) [49]
- [Using the menu on the TV screen](#) [50]
- [Enjoying video/sound from the connected device](#) [51]
- [Enjoying sound of an ARC \(Audio Return Channel\) compatible TV](#) [52]
- [Watching HDCP 2.2 Copyright-protected Content](#) [53]

Playing content from an iPhone/iPad/iPod

- [Enjoying audio content stored on an iPhone/iPod via the USB port](#) [54]
- [Enjoying audio content from iTunes or an iPhone/iPad/iPod via the network \(AirPlay\)](#) [55]
- [Enjoying audio content using the BLUETOOTH function \(Pairing operation\)](#) [56]
- [Compatible iPhone/iPad/iPod models](#) [57]
- [Notes on iPhone/iPad/iPod](#) [58]

Playing content from a USB device

- [Enjoying content stored on a USB device \[59\]](#)
- [USB specifications and Compatible USB devices \[60\]](#)
- [Notes on USB devices \[61\]](#)

Listening to the radio

- [Listening to FM radio \[62\]](#)
- [Presetting FM radio stations \(Preset Memory\) \[63\]](#)
- [Naming preset stations \(Name Input\) \[64\]](#)
- [Tuning to a station directly \(Direct Tuning\) \[65\]](#)
- [Receiving RDS broadcasts \(for European and Asia-Pacific models only\) \[66\]](#)

Enjoying sound effects

- [Selecting a sound field \(Sound Field\) \[67\]](#)
- [Resetting sound fields to the default settings \[68\]](#)
- [Adjusting the equalizer \(Equalizer\) \[69\]](#)
- [Enjoying clear and dynamic sound at a low volume \(Sound Optimizer\) \[70\]](#)
- [Enjoying more natural sound with speakers installed in the ceiling \(In-Ceiling Speaker Mode\) \[71\]](#)
- [Enjoying high-fidelity sound \(Pure Direct\) \[72\]](#)

Displaying the mobile device display on the TV screen (Screen mirroring)

- [Displaying the mobile device display on the TV screen \(Screen mirroring\) \[73\]](#)

Using Network Features

About network features

- [What you can do with network features \[74\]](#)

Setting up a wired LAN connection (for wired LAN connections only)

- [Connecting the receiver to the network using a LAN cable \(for wired LAN connections only\) \[75\]](#)
- [Setting up a wired LAN connection \[76\]](#)

Setting up a wireless LAN connection (for wireless LAN connections only)

- [Connecting the receiver to the network using the wireless LAN antenna \(for wireless LAN connections only\) \[77\]](#)
- [Setting up a wireless LAN connection \[78\]](#)

Enjoying content stored on a server on the home network

- [Enjoying content stored on a server on the home network \[79\]](#)
- [Deleting a server from the server list \[80\]](#)
- [Setting whether to control this receiver from a controller device on the home network \(Renderer Access Control\) \[81\]](#)

Enjoying audio content from iTunes or an iPhone/iPad/iPod via the network (AirPlay)

- [Compatible iPhone/iPad/iPod models \[82\]](#)
- [Enjoying audio content from iTunes or an iPhone/iPad/iPod via the network \(AirPlay\) \[83\]](#)

Enjoying internet music services

- [Enjoying music services offered on the Internet \[84\]](#)

Using “SongPal” to control the receiver from a smartphone or tablet device

- [Controlling the receiver using a smartphone or tablet device \(SongPal\) \[85\]](#)
- [Listening to the same music on multiple devices/Listening to different music in a different location \(SongPal Link\) \[86\]](#)

Using TV SideView to control the receiver from a smartphone or tablet device

- [Registering TV SideView device to the receiver \[87\]](#)

- [Checking the registered TV SideView device \(Registered Remote Devices\) \[88\]](#)
- [Deleting TV SideView device from device list \[89\]](#)

Using Google Cast™ to enjoy audio content from a smartphone or tablet device

- [Using Google Cast™ to enjoy audio content from a smartphone or tablet device \[90\]](#)

Setting whether to control this receiver from a device on the home network

- [Setting whether to control this receiver from a controller device on the home network \(Renderer Access Control\) \[91\]](#)
- [Enabling automatic access from a newly detected controller device \(Auto Renderer Access Permission\) \[92\]](#)
- [Deleting devices from the device list in Renderer Access Control \[93\]](#)

Using BLUETOOTH Features

About BLUETOOTH Features

- [What you can do with BLUETOOTH features \[94\]](#)

Enjoying audio content stored on a BLUETOOTH device

- [Enjoying audio content stored on a BLUETOOTH device with a one-touch connection \(NFC\) \[95\]](#)
- [Enjoying audio content using the BLUETOOTH function \(Pairing operation\) \[96\]](#)
- [Controlling a BLUETOOTH device using the remote control \[97\]](#)
- [Compatible BLUETOOTH version and profiles \[98\]](#)

Listening with BLUETOOTH headphones

- [Listening with BLUETOOTH headphones \(Pairing operation\) \[99\]](#)
- [Compatible BLUETOOTH version and profiles \[100\]](#)

Using “SongPal” to control the receiver from a smartphone or tablet device

- [Controlling the receiver using a smartphone or tablet device \(SongPal\) \[101\]](#)
- [Listening to the same music on multiple devices/Listening to different music in a different location \(SongPal Link\) \[102\]](#)

Using the Multi-Zone Features (for STR-DN1060 only)

Overview of multi-zone features (for STR-DN1060 only)

- [What you can do with multi-zone features \(for STR-DN1060 only\) \[103\]](#)
- [Available inputs for each zone \(for STR-DN1060 only\) \[104\]](#)

Enjoying sound from speakers located in other rooms (for STR-DN1060 only)

- [1. Connecting the speakers in Zone 2 and/or Zone 3 \(for STR-DN1060 only\) \[105\]](#)
- [2. Assigning speakers for Zone 2 \(for STR-DN1060 only\) \[106\]](#)
- [3. Assigning speakers for Zone 3 \(for STR-DN1060 only\) \[107\]](#)
- [4. Enjoying sound in Zone 2 and/or Zone 3 \(for STR-DN1060 only\) \[108\]](#)

Enjoying sound from speakers located in other rooms using another amplifier (for STR-DN1060 only)

- [1. Connecting another amplifier in Zone 2 \(for STR-DN1060 only\) \[109\]](#)
- [2. Setting the volume control for Zone 2 \(Zone2 Line Out\) \(for STR-DN1060 only\) \[110\]](#)
- [3. Enjoying sound using another amplifier in Zone 2 \(for STR-DN1060 only\) \[111\]](#)

Enjoying video and sound in another room using a TV or another receiver (for STR-DN1060 only)

- [1. Connecting another amplifier or TV in the HDMI zone \(for STR-DN1060 only\) \[112\]](#)
- [2. Selecting the method to use the HDMI OUT B jack \(HDMI Out B Mode\) \(for STR-DN1060 only\) \[113\]](#)
- [3. Setting the priority for the main zone \(Priority\) \(for STR-DN1060 only\) \[114\]](#)
- [4. Enjoying video and sound in another location by connecting another amplifier or TV using HDMI connections \(HDMI zone\) \(for STR-DN1060 only\) \[115\]](#)

Using Other Features

Interlocking with BRAVIA TV and other devices (“BRAVIA” Sync)

- [What is “BRAVIA” Sync? \[116\]](#)
- [Preparing for “BRAVIA” Sync \[117\]](#)
- [Enjoying an input source from a connected device immediately \(One-Touch Play\) \[118\]](#)
- [Enjoying TV sound from the speakers connected to the receiver \(System Audio Control\) \[119\]](#)
- [Turning off the receiver and connected devices simultaneously with the TV \(System Power-Off\) \[120\]](#)
- [Selecting the optimum picture quality and sound field automatically \(Scene Select\) \[121\]](#)
- [About Home Theatre Control \[122\]](#)
- [Operating the receiver menu using the TV remote control \(Remote Easy Control\) \[123\]](#)
- [About Controlling MHL devices \[124\]](#)

Enjoying video and sound with your desired way of use

- [Switching the monitors that output the HDMI video signals \(for STR-DN1060 only\) \[125\]](#)
- [Switching between digital and analog audio \(Input Mode\) \[126\]](#)
- [Using other video/audio input jacks \(Input Assign\) \[127\]](#)

Saving and recalling various settings for the receiver (Custom Preset)

- [About Custom Preset \[128\]](#)
- [Saving the settings to a preset \[129\]](#)
- [Recalling the settings saved to the scene \[130\]](#)
- [Items for which you can save settings and the default values for each item \[131\]](#)

Using the sleep timer

- [Using the sleep timer \(Sleep\) \[132\]](#)

Checking information on the receiver

- [Viewing information on the display panel \[133\]](#)

Adjusting Settings

Easy Setup

- [Setting up the receiver using Easy Setup \[134\]](#)

Speaker Settings

- [1. About Auto Calibration \[135\]](#)
- [2. Before you perform Auto Calibration \[136\]](#)
- [3. Connecting the optimizer microphone \[137\]](#)
- [4. Selecting the front speakers \[138\]](#)
- [5. Performing Auto Calibration \[139\]](#)
- [6. Checking Auto Calibration results \[140\]](#)
- [Calibrating the phase characteristics of the speakers \(A.P.M. \(Automatic Phase Matching\)\) \[141\]](#)
- [Selecting the Auto Calibration type \(Calibration Type\) \[142\]](#)
- [Setting how to assign the surround speaker terminals \(Speaker Pattern/Surround SP Assign\) \(for STR-DN1060 only\) \[143\]](#)
- [Selecting the speaker pattern and setting the assignment for the speaker terminals \(Speaker Pattern/Sur Back SP Assign\) \[144\]](#)
- [Adjusting the speaker size \(Size\) \[145\]](#)
- [Adjusting the speaker distance \(Distance\) \[146\]](#)
- [Adjusting the speaker level \(Level\) \[147\]](#)
- [Outputting a test tone from each speaker \(Test Tone\) \[148\]](#)
- [Setting the crossover frequency of the speakers \(Crossover Frequency\) \[149\]](#)
- [Adjusting the equalizer \(Equalizer\) \[150\]](#)
- [Lifting up the sound of the center speaker \(Center Speaker Lift Up\) \[151\]](#)
- [Setting the height from the floor to the ceiling speakers \(Ceiling Speaker Height\) \[152\]](#)
- [Selecting the unit of measurement \(Distance Unit\) \[153\]](#)

Audio Settings

- [Playing audio signals with high-quality sound \(Digital Legato Linear \(D.L.L.\)\) \[154\]](#)
- [Enjoying clear and dynamic sound at a low volume \(Sound Optimizer\) \[155\]](#)
- [Selecting a sound field \(Sound Field\) \[156\]](#)

- [Selecting the HD-D.C.S. effect type \(HD-D.C.S. Type\) \[157\]](#)
- [Enjoying more natural sound with speakers installed in the ceiling \(In-Ceiling Speaker Mode\) \[158\]](#)
- [Enjoying high-fidelity sound \(Pure Direct\) \[159\]](#)
- [Setting the low-pass filter for the subwoofer output \(Subwoofer Low Pass Filter\) \[160\]](#)
- [Synchronizing audio with video output \(A/V Sync\) \[161\]](#)
- [Time-aligning the LFE \(low frequency effect\) channel \(LFE Time Alignment\) \[162\]](#)
- [Adjusting the volume automatically \(Advanced Auto Volume\) \[163\]](#)
- [Selecting the language of digital broadcasts \(Dual Mono\) \[164\]](#)
- [Compressing the dynamic range \(Dynamic Range Compressor\) \[165\]](#)

Screen Settings

- [Setting the screen aspect ratio of the TV \(TV Type\) \[166\]](#)
- [Outputting 24p video signals when watching content from other networks \(Network content 24p Output\) \[167\]](#)
- [Enjoying 4K content \(4K Output\) \[168\]](#)
- [Setting the color space conversion for the video signal from HDMI jacks \(YCbCr/RGB \(HDMI\)\) \[169\]](#)
- [Outputting the Deep Color video signal from HDMI jacks \(HDMI Deep Color Output\) \[170\]](#)
- [Smoothing the gradation of video signals \(SBM \(Super Bit Mapping\)\) \[171\]](#)

HDMI Settings

- [Upscaling video signals to 4K \(HDMI In 4K Scaling\) \[172\]](#)
- [Controlling HDMI devices \(Control for HDMI\) \[173\]](#)
- [Passing HDMI signals through \(Standby Through\) \[174\]](#)
- [Setting the HDMI audio signal output of connected devices \(Audio Out\) \[175\]](#)
- [Setting the level of the subwoofer \(Subwoofer Level\) \[176\]](#)
- [Selecting the method to use the HDMI OUT B jack \(HDMI Out B Mode\) \(for STR-DN1060 only\) \[177\]](#)
- [Setting the priority for the main zone \(Priority\) \(for STR-DN1060 only\) \[178\]](#)
- [Speeding up the display when switching the HDMI input \(Fast View\) \[179\]](#)
- [Automatically switching the input when an MHL device is connected or being played \(MHL Auto Input\) \[180\]](#)

Input Settings

- [Changing the assignment and display for the input jacks \[181\]](#)
- [Changing the name for each input \(Name\) \[182\]](#)

Network Settings

- [Setting up a wired LAN connection \[183\]](#)
- [Setting up a wireless LAN connection \[184\]](#)
- [Checking the network connection status \(Network Connection Status\) \[185\]](#)
- [Checking whether the network connection has been made properly \(Network Connection Diagnostics\) \[186\]](#)
- [Setting the priority radio frequency channel for Screen mirroring \(Screen mirroring RF Setting\) \[187\]](#)
- [Displaying the connected home network server \(Connection Server Settings\) \[188\]](#)
- [Enabling automatic access from a newly detected controller device \(Auto Renderer Access Permission\) \[189\]](#)
- [Setting whether to control this receiver from a controller device on the home network \(Renderer Access Control\) \[190\]](#)
- [Checking the registered TV SideView device \(Registered Remote Devices\) \[191\]](#)
- [Enabling the network function even when this receiver is in standby mode \(Remote Start\) \[192\]](#)
- [Turning on the control mode for maintenance \(External Control\) \[193\]](#)

Bluetooth Settings

- [Selecting the BLUETOOTH mode \(Bluetooth Mode\) \[194\]](#)
- [Checking the BLUETOOTH device list \(Device List\) \[195\]](#)
- [Setting the Bluetooth Standby mode \(Bluetooth Standby\) \[196\]](#)
- [Setting BLUETOOTH audio codecs \(Bluetooth Codec - AAC/Bluetooth Codec - LDAC\) \[197\]](#)
- [Setting the BLUETOOTH sound quality \(Wireless Playback Quality\) \[198\]](#)

Zone Settings (for STR-DN1060 only)

- [Turning the power for Zone 2/Zone 3/HDMI zone on/off \(Power\) \(for STR-DN1060 only\) \[199\]](#)

- [Selecting source signals for Zone 2/Zone 3/HDMI zone \(Input\) \(for STR-DN1060 only\) \[200\]](#)
- [Adjusting the volume for Zone 2/Zone 3 \(Volume\) \(for STR-DN1060 only\) \[201\]](#)
- [Setting the volume control for Zone 2 \(Zone2 Line Out\) \(for STR-DN1060 only\) \[202\]](#)

System Settings

- [Selecting the language \(Language\) \(for USA, Canadian, European and Australian models only\) \[203\]](#)
- [Tuning on/off the display for the volume level or sound field \(Auto Display\) \[204\]](#)
- [Reducing the startup time \(Quick Start/Network Standby\) \(for USA, Canadian and Asia-Pacific models only\) \[205\]](#)
- [Setting standby mode \(Auto Standby\) \[206\]](#)
- [Switching the brightness of the display panel \(Dimmer\) \[207\]](#)
- [Using the sleep timer \(Sleep\) \[208\]](#)
- [Receiving information on newer software \(Software Update Notification\) \[209\]](#)
- [Deleting personal data \(Initialize Personal Information\) \[210\]](#)
- [Assigning a name to the receiver \(Device Name\) \[211\]](#)
- [Checking the software version and MAC address of the receiver \(System Information\) \[212\]](#)
- [Checking software license information \(Software License Information\) \[213\]](#)
- [Updating the software automatically \(Auto Update Settings\) \[214\]](#)
- [Updating the software \(Software Update\) \[215\]](#)

Using the menu on the display panel

- [Operating the receiver with the menu on the display panel \[216\]](#)
- [Viewing information on the display panel \[217\]](#)

Reverting to the factory default settings

- [Reverting to the factory default settings \[218\]](#)

Troubleshooting

Error messages

- [PROTECTOR \[219\]](#)
- [An over-current from the USB port was detected. \[220\]](#)
- [List of messages after Auto Calibration measurements \[221\]](#)

General

- [The receiver is turned off automatically. \[222\]](#)
- [Cannot find an available input when connecting several digital devices. \[223\]](#)

Image

- [No image appears on the TV. \[224\]](#)
- [No 3D image appears on the TV. \[225\]](#)
- [No 4K image appears on the TV. \[226\]](#)
- [No image is output from the TV when the receiver is in standby mode. \[227\]](#)
- [The home menu does not appear on the TV screen. \[228\]](#)
- [The display panel is turned off. \[229\]](#)

Sound

- [No sound or only a very low level of sound is heard, no matter which device is selected. \[230\]](#)
- [There is severe humming or noise. \[231\]](#)
- [No sound or only a very low level of sound is heard from specific speakers. \[232\]](#)
- [There is no sound from a specific device. \[233\]](#)
- [There is no sound from the TV via the HDMI OUT \(ARC\) jack when using the Audio Return Channel function. \[234\]](#)
- [The left and right sound is unbalanced or reversed. \[235\]](#)
- [Dolby Digital or DTS multi-channel sound is not reproduced. \[236\]](#)
- [The surround effect cannot be obtained. \[237\]](#)
- [A test tone is not output from the speakers. \[238\]](#)
- [A test tone is output from a different speaker than the speaker displayed on the TV screen. \[239\]](#)
- [No sound is output from the TV when the receiver is in standby mode. \[240\]](#)

Tuner

- [The FM reception is poor. \[241\]](#)
- [The FM stereo reception is poor. \[242\]](#)
- [You cannot tune to radio stations. \[243\]](#)
- [RDS does not work \(for European and Asia-Pacific models only\). \[244\]](#)
- [The RDS information that you want does not appear \(for European and Asia-Pacific models only\). \[245\]](#)

iPhone/iPad/iPod

- [The sound is distorted. \[246\]](#)
- [There is no sound from an iPhone/iPod. \[247\]](#)
- [An iPhone/iPad/iPod cannot be charged. \[248\]](#)
- [An iPhone/iPad/iPod cannot be operated. \[249\]](#)
- [The ringtone volume of an iPhone does not change. \[250\]](#)

USB devices

- [Are you using a compatible USB device? \[251\]](#)
- [There is noise, skipping, or distorted sound. \[252\]](#)
- [A USB device is not recognized. \[253\]](#)
- [Playback does not start. \[254\]](#)
- [A USB device cannot be connected to the USB port. \[255\]](#)
- [Erroneous display. \[256\]](#)
- [An audio file cannot be played. \[257\]](#)

Network connection

- [Cannot connect to the network using WPS via a wireless LAN connection. \[258\]](#)
- [Cannot connect to the network. \[259\]](#)
- [Cannot control the receiver using a “SongPal” device. \[260\]](#)
- [Cannot control the receiver using a TV SideView device. \[261\]](#)
- [Cannot select the Network Settings menu. \[262\]](#)

Home Network

- [Cannot connect to the network. \[263\]](#)

- A server does not appear in the server list. ([Cannot find the server.] appears on the TV screen.) [264]
- Playback does not start, or the player does not automatically proceed to the next track or file. [265]
- The sound skips during playback. [266]
- [No playable file in this category.] appears. [267]
- Cannot play copyrighted files. [268]
- Cannot select a previously selected track. [269]
- Controller devices or applications on the home network cannot connect to the receiver. [270]
- The receiver cannot be turned on by devices on a network. [271]

AirPlay

- The receiver cannot be found from an iPhone/iPad/iPod or iTunes. [272]
- The sound skips. [273]
- The receiver cannot be operated. [274]

Music Services

- Cannot connect the receiver to a service. [275]
- The sound skips. [276]

BLUETOOTH device

- Pairing cannot be done. [277]
- Cannot make a BLUETOOTH connection. [278]
- The sound skips or fluctuates, or the connection is lost. [279]
- The sound of your BLUETOOTH device cannot be heard on the receiver. [280]
- Severe humming or noise. [281]
- Cannot control the receiver using a “SongPal” device. [282]

“BRAVIA” Sync (Control for HDMI)

- The Control for HDMI function does not work. [283]
- TV sound cannot be heard from the speakers connected to the receiver. [284]
- An MHL-compatible source device cannot be charged. [285]

- [No image from an MHL-compatible source device. \[286\]](#)

Remote control

- [The remote control does not function. \[287\]](#)

If the problem is not solved

- [Reverting to the factory default settings \[288\]](#)
- [Resetting sound fields to the default settings \[289\]](#)
- [Customer support websites \[290\]](#)

Other Information

Trademarks

- [Trademarks \[291\]](#)

[1] Parts and Controls | Receiver (STR-DN1060)

Front panel (STR-DN1060) (upper section)

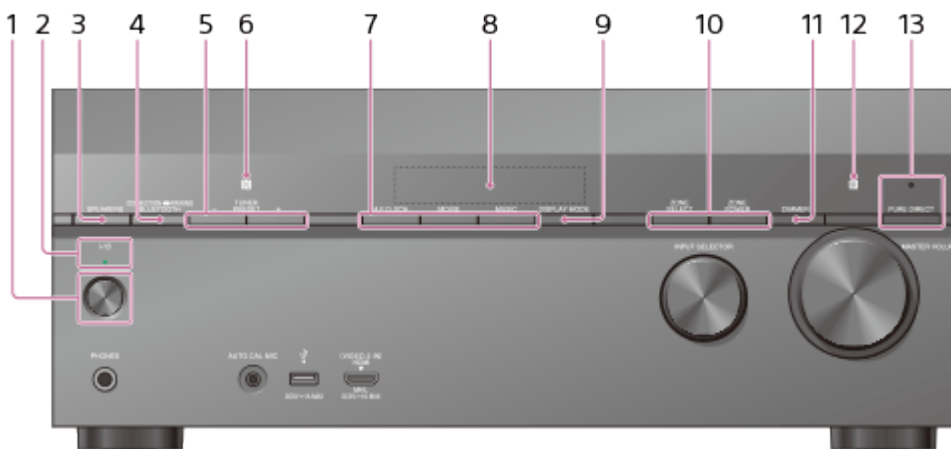

1. **I/O (on/standby)**
2. **On/standby indicator**
3. **SPEAKERS**
4. **CONNECTION PAIRING BLUETOOTH**

Operates the BLUETOOTH function.

5. **TUNER PRESET +/-**

6. **NFC sensor**

7. **A.F.D./2CH, MOVIE, MUSIC**

8. **Display panel**

9. **DISPLAY MODE**

Switches information on the display panel.

10. **ZONE SELECT, ZONE POWER**

11. **DIMMER**

Adjusts the brightness of the display panel in 3 levels.

12. **Remote control sensor**

Receives signals from remote control.

13. **PURE DIRECT**

The indicator above the button lights up when the Pure Direct function is activated.

[2] Parts and Controls | Receiver (STR-DN1060)

Front panel (STR-DN1060) (lower section)

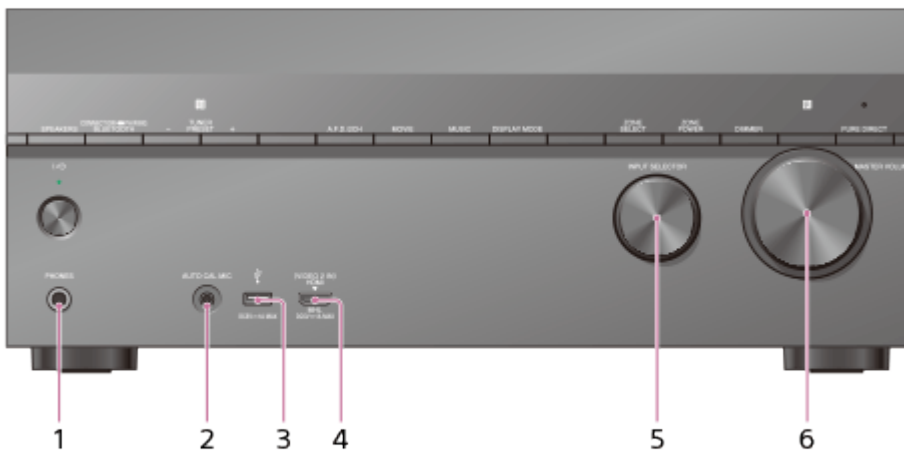

1. **PHONES jack**

Connect headphones here.

2. **AUTO CAL MIC jack**

3. **ψ (USB) port**

4. **HDMI/MHL (VIDEO 2 IN) jack**

5. **INPUT SELECTOR**

6. **MASTER VOLUME**

On/standby indicator (STR-DN1060)

- Green: The receiver is turned on.
- Amber: The receiver is in standby mode, and:
 - [Control for HDMI], [Remote Start], [Bluetooth Standby] (*) or [Quick Start/Network Standby] (**) is set to [On].
 - [Standby Through] is set to [On] or [Auto].
 - Power for Zone 2/3 or HDMI zone is set to [On].

The indicator turns off when the receiver is in standby mode, [Control for HDMI], [Standby Through], [Remote Start], [Bluetooth Standby] (*) and [Quick Start/Network Standby] (**) are set to [Off], and the power for all zones is set to [Off].

* When [Bluetooth Standby] is activated, the indicator only lights in amber when a device has been paired with the receiver. If there are no devices paired with the receiver, the indicator turns off when the receiver is in standby mode.

** For USA, Canadian and Asia-Pacific models only.

Indicators on the display panel

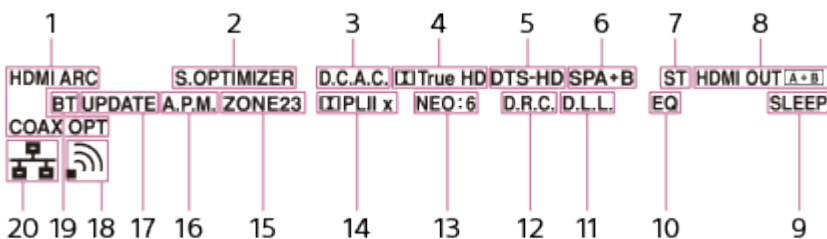

1. Input indicator

Lights up to indicate the current input.

HDMI

The receiver recognizes devices connected via an HDMI IN jack.

ARC





TV input is selected and Audio Return Channel (ARC) signals are detected.

COAX

Digital signals are input through the COAXIAL jack.

OPT

Digital signals are input through the OPTICAL jack.

2. **S.OPTIMIZER**
Lights up when the Sound Optimizer function is activated.
3. **D.C.A.C.**
Lights up when the measurement results of the Auto Calibration function are applied.
4. **Dolby Digital Surround indicator**
The applicable indicator lights up when the receiver is decoding the corresponding Dolby Digital format signals.
: Dolby Digital
 **TrueHD**: Dolby TrueHD
5. **DTS(-HD) indicator**
The applicable indicator lights up when the receiver is decoding the corresponding DTS format signals.
DTS: DTS
DTS-HD: DTS-HD
6. **Speaker system indicator**
7. **Tuning indicator**
ST
Lights up when the receiver tunes to a stereo broadcast.
8. **HDMI OUT A + B (for STR-DN1060 only)**
9. **SLEEP**
Lights up when the sleep timer is activated.
10. **EQ**
Lights up when the equalizer is activated.
11. **D.L.L.**
Lights up when the Digital Legato Linear (D.L.L.) function is activated.
12. **D.R.C.**
Lights up when dynamic range compression is activated.
13. **NEO:6**
Lights up when DTS Neo:6 Cinema/Music decoding is activated.
14. **Dolby Pro Logic indicator**
The applicable indicator lights up when the receiver performs Dolby Pro Logic processing. This matrix surround decoding technology can enhance input signals.
 **PL**: Dolby Pro Logic
 **PLII**: Dolby Pro Logic II
 **PLIIX**: Dolby Pro Logic IIx
15. **ZONE, ZONE2, ZONE3 (for STR-DN1060 only)**
ZONE2, ZONE3 or both light up while the power to the corresponding zone is on.
ZONE and HDMI OUT light up when the power for HDMI zone is on.
16. **A.P.M.**
Lights up when the A.P.M. (Automatic Phase Matching) function is activated. You can only set the A.P.M. function in the D.C.A.C. (Digital Cinema Auto Calibration) function.
17. **UPDATE**
Lights up when new software is available.

18. Wireless LAN signal strength indicator

Lights up to show the strength of the wireless LAN signal.

- : No signal.
- ▬ : Weak signal.
- ▬▬ : Moderate signal.
- ▬▬▬ : Strong signal.

19. BT

Lights up when a BLUETOOTH device is connected. Flashes while connecting.

20. Wired LAN indicator

Lights up when a LAN cable is connected.

[5] Parts and Controls | Receiver (STR-DN1060)

Rear panel (STR-DN1060)

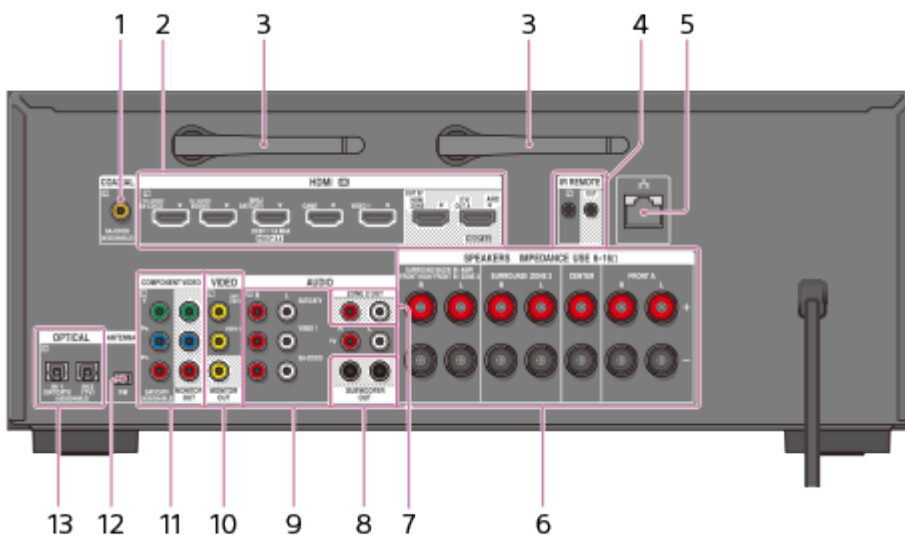

1. COAXIAL IN jack

2. HDMI IN/OUT (*) jacks

3. Wireless LAN antenna

4. IR REMOTE IN/OUT jacks

- You can control the receiver from a distance by connecting an IR repeater (not supplied) to the IR REMOTE IN jack.
- You can start or stop playback of devices such as a CD player connected to the receiver by connecting an IR Blaster (not supplied) to the IR REMOTE OUT jack.

5. LAN port

6. SPEAKERS terminals

7. ZONE 2 OUT jacks

8. SUBWOOFER OUT jacks

9. **AUDIO IN jacks**
10. **VIDEO IN/OUT (*) jacks**
11. **COMPONENT VIDEO IN/OUT (*) jacks**
12. **FM ANTENNA terminal**
13. **OPTICAL IN jacks**

* Connect a TV to the corresponding output jacks to watch video input from these jacks.

- **HDMI IN jacks:** HDMI OUT A (TV) or HDMI OUT B/HDMI ZONE jack
- **VIDEO IN jacks:** VIDEO MONITOR OUT jack
- **COMPONENT VIDEO IN jacks:** COMPONENT VIDEO MONITOR OUT jack

For details, see "[Connecting a TV \(for STR-DN1060\).](#)"

[6] Parts and Controls | Receiver (STR-DN860)

Front panel (STR-DN860) (upper section)

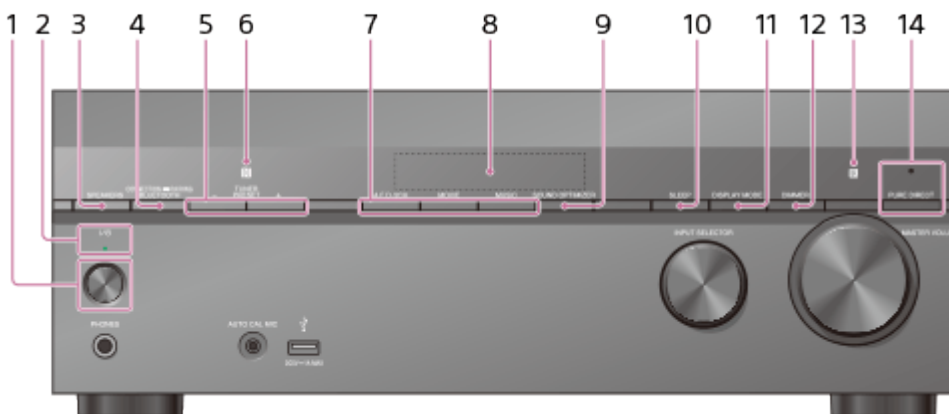

1. **I/⏻ (on/standby)**
2. **On/standby indicator**
3. **SPEAKERS**
4. **CONNECTION PAIRING BLUETOOTH**
Operates the BLUETOOTH function.
5. **TUNER PRESET +/-**
6. **NFC sensor**
7. **A.F.D./2CH, MOVIE, MUSIC**
8. **Display panel**
9. **SOUND OPTIMIZER**
10. **SLEEP**
11. **DISPLAY MODE**
Switches information on the display panel.
12. **DIMMER**

Adjusts the brightness of the display panel in 3 levels.

13. **Remote control sensor**

Receives signals from remote control.

14. **PURE DIRECT**

The indicator above the button lights up when the Pure Direct function is activated.

[7] Parts and Controls | Receiver (STR-DN860)

Front panel (STR-DN860) (lower section)

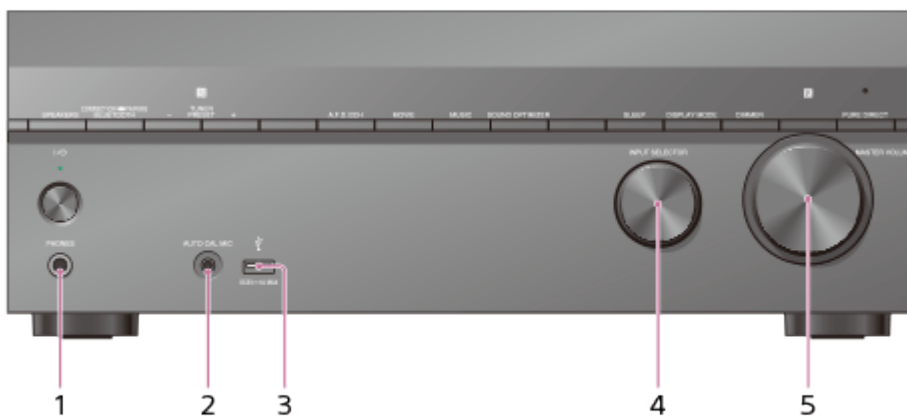

1. **PHONES jack**

Connect headphones here.

2. **AUTO CAL MIC jack**

3. **ψ (USB) port**

4. **INPUT SELECTOR**

5. **MASTER VOLUME**

[8] Parts and Controls | Receiver (STR-DN860)

On/standby indicator (STR-DN860)

- Green: The receiver is turned on.
- Amber: The receiver is in standby mode, and:
 - [Control for HDMI], [Remote Start], [Bluetooth Standby] (*) or [Quick Start/Network Standby] (**) is set to [On].
 - [Standby Through] is set to [On] or [Auto].

The indicator turns off when the receiver is in standby mode, [Control for HDMI], [Standby

Through], [Remote Start], [Bluetooth Standby] (*) and [Quick Start/Network Standby] (**) are set to [Off].

* When [Bluetooth Standby] is activated, the indicator only lights in amber when a device has been paired with the receiver. If there are no devices paired with the receiver, the indicator turns off when the receiver is in standby mode.

** For USA, Canadian and Asia-Pacific models only.

[9] Parts and Controls | Receiver (STR-DN860)

Indicators on the display panel

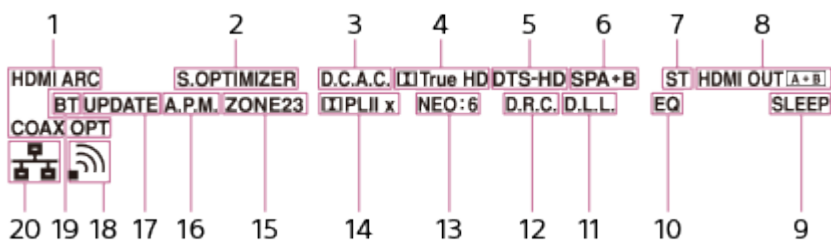

1. **Input indicator**

Lights up to indicate the current input.

HDMI

The receiver recognizes devices connected via an HDMI IN jack.

ARC

TV input is selected and Audio Return Channel (ARC) signals are detected.

COAX

Digital signals are input through the COAXIAL jack.

OPT

Digital signals are input through the OPTICAL jack.

2. **S.OPTIMIZER**

Lights up when the Sound Optimizer function is activated.

3. **D.C.A.C.**

Lights up when the measurement results of the Auto Calibration function are applied.

4. **Dolby Digital Surround indicator**

The applicable indicator lights up when the receiver is decoding the corresponding Dolby Digital format signals.

: Dolby Digital

 **TrueHD**: Dolby TrueHD

5. **DTS(-HD) indicator**

The applicable indicator lights up when the receiver is decoding the corresponding DTS format signals.

DTS: DTS

DTS-HD: DTS-HD

6. **Speaker system indicator**

7. **Tuning indicator**

ST

Lights up when the receiver tunes to a stereo broadcast.

8. **HDMI OUT A + B (for STR-DN1060 only)**

9. **SLEEP**

Lights up when the sleep timer is activated.

10. **EQ**

Lights up when the equalizer is activated.

11. **D.L.L.**

Lights up when the Digital Legato Linear (D.L.L.) function is activated.

12. **D.R.C.**

Lights up when dynamic range compression is activated.

13. **NEO:6**

Lights up when DTS Neo:6 Cinema/Music decoding is activated.

14. **Dolby Pro Logic indicator**

The applicable indicator lights up when the receiver performs Dolby Pro Logic processing. This matrix surround decoding technology can enhance input signals.

 **PL:** Dolby Pro Logic

 **PLII:** Dolby Pro Logic II

 **PLIIX:** Dolby Pro Logic IIx

15. **ZONE, ZONE2, ZONE3 (for STR-DN1060 only)**

ZONE2, ZONE3 or both light up while the power to the corresponding zone is on.

ZONE and HDMI OUT light up when the power for HDMI zone is on.

16. **A.P.M.**

Lights up when the A.P.M. (Automatic Phase Matching) function is activated. You can only set the A.P.M. function in the D.C.A.C. (Digital Cinema Auto Calibration) function.

17. **UPDATE**

Lights up when new software is available.

18. **Wireless LAN signal strength indicator**

Lights up to show the strength of the wireless LAN signal.

 : No signal.

 : Weak signal.

 : Moderate signal.

 : Strong signal.

19. **BT**

Lights up when a BLUETOOTH device is connected. Flashes while connecting.

20. **Wired LAN indicator**

Lights up when a LAN cable is connected.

Rear panel (STR-DN860)

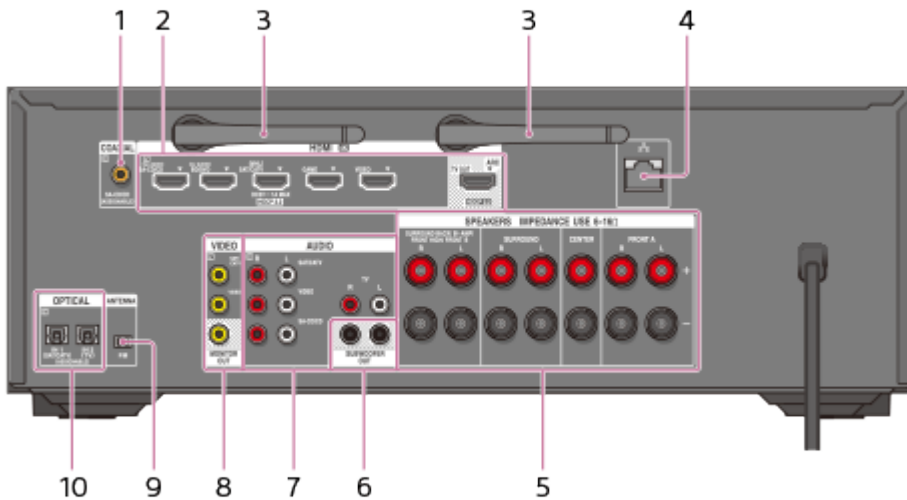

1. **COAXIAL IN** jack
2. **HDMI IN/OUT (*)** jacks
3. **Wireless LAN** antenna
4. **LAN** port
5. **SPEAKERS** terminals
6. **SUBWOOFER OUT** jacks
7. **AUDIO IN** jacks
8. **VIDEO IN/OUT (*)** jacks
9. **FM ANTENNA** terminal
10. **OPTICAL IN** jacks

* Connect a TV to the corresponding output jacks to watch video input from these jacks.

- **HDMI IN** jacks: HDMI OUT jack
- **VIDEO IN** jacks: MONITOR OUT jack

For details, see "[Connecting a TV \(for STR-DN860\)](#)."

Remote control (upper section)

Use the supplied remote control to operate this receiver.

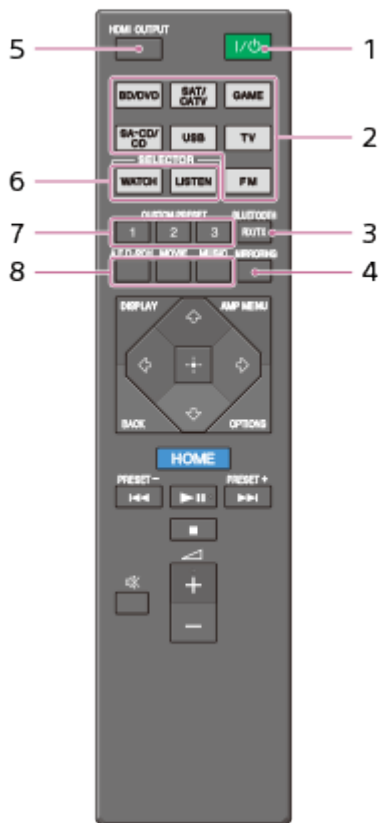

1. I/O (on/standby)

Turns the receiver on or sets it to the standby mode.

Saving power in standby mode

Save power by setting the receiver as follows:

- Set [Control for HDMI], [Remote Start], [Bluetooth Standby] and [Quick Start/Network Standby] (*) to [Off].
- Turn off the power for Zone 2, Zone 3 and HDMI zone. (for STR-DN1060 only)

2. Input buttons

Select the input channel connected to the device you want to use.

When you press any of the input buttons, the receiver turns on.

3. BLUETOOTH RX/TX

Switches the BLUETOOTH mode of the receiver. (Disabled while the BLUETOOTH function or Screen mirroring function is activated.)

In BLUETOOTH RX mode, the receiver receives and outputs audio from the remote device.

In BLUETOOTH TX mode, the receiver sends audio to the remote device.

4. MIRRORING

Starts the Screen mirroring function.

5. HDMI OUTPUT

Switches the output for two monitors connected to the HDMI OUT A (TV) and HDMI OUT B/HDMI ZONE jacks. Output is toggled between [HDMI A], [HDMI B], [HDMI A+B] and [HDMI OFF] each time the button is pressed. Select [HDMI OFF] to turn off the output for HDMI OUT A and HDMI OUT B jacks. (for STR-DN1060 only)

Turns the output for HDMI TV OUT on/off. (for STR-DN860 only)

6. WATCH, LISTEN

Select [Watch] or [Listen] on the home menu directly. When pressing these buttons on the Watch or Listen screen, you can move the focus to select the desired input.

7. CUSTOM PRESET (1, 2, 3)

Saves and recalls various settings for the receiver. Press to select the custom preset setting(s). Press and hold to save the current settings to a preset.

8. A.F.D./2CH, MOVIE, MUSIC

Select a sound field.

* For USA, Canadian and Asia-Pacific models only.

Note

- The above explanations are intended to serve as examples.
- Depending on the model of your connected device, some functions explained in this section may not work with the supplied remote control.

[12] Parts and Controls | Remote control



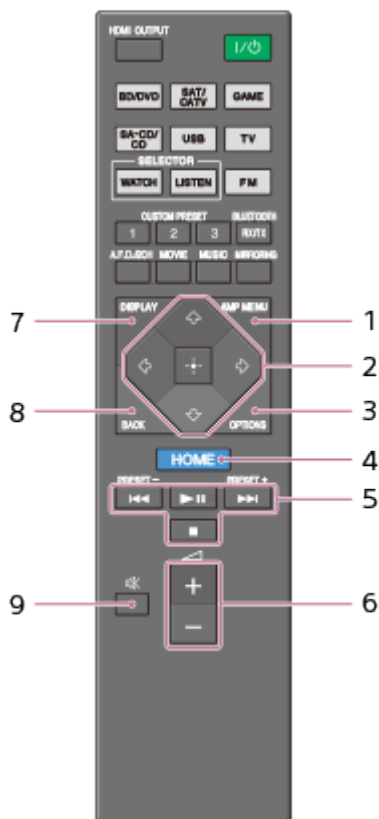

Remote control (lower section)

Use the supplied remote control to operate this receiver.



1. AMP MENU

Displays the menu to operate the receiver.

2. , , , , 

Press , , ,  to select the menu items. Then press  to enter the selection.

3. **OPTIONS**

Display and select items from the options menus.

4. **HOME**

Displays the home menu on the TV screen.

5. , , , 

Skip, play, pause, stop operation.

PRESET +/-

Select preset stations or channels. Press and hold to scan stations automatically.

6.  +(*)/-

Adjust the volume level of all speakers at the same time.

7. **DISPLAY**



Displays information on the TV screen.

8. **BACK**

Returns to the previous menu or exits a menu or on-screen guide that is displayed on the TV screen.

9. 

Turns off the sound temporarily. Press the button again to restore the sound.

* The  and + buttons have tactile dots. Use the tactile dots as a reference when operating the receiver.

Note

- The above explanations are intended to serve as examples.
- Depending on the model of your connected device, some functions explained in this section may not work with the supplied remote control.

[13] Preparation | 1. Installing speakers

Installing 7.1-channel speaker system using surround back speakers

You can enjoy high-fidelity reproduction of recorded sound from DVD or Blu-ray Disc software in 6.1-channel or 7.1-channel format.

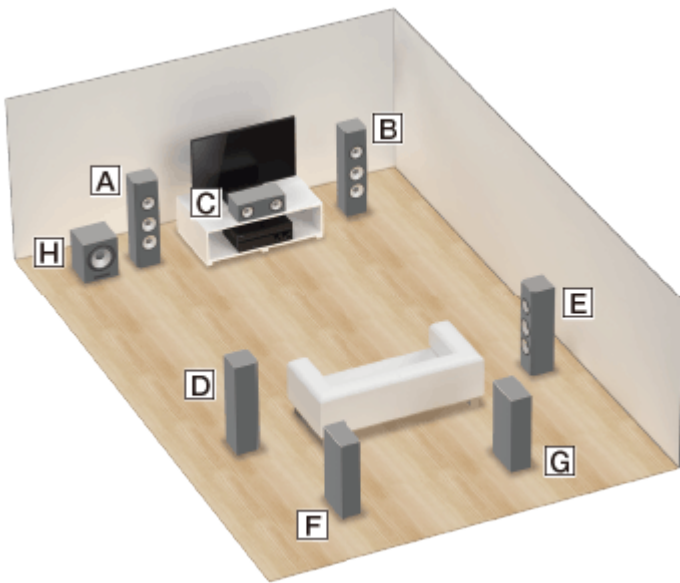

- A Front speaker (Left)**
- B Front speaker (Right)**
- C Center speaker**
- D Surround speaker (Left)**
- E Surround speaker (Right)**
- F Surround back speaker (Left)**
- G Surround back speaker (Right)**
- H Subwoofer**

When using a 6.1-channel connection

The following illustration is an example of an arrangement with only one surround back speaker. Place the surround back speaker behind the position from which you will listen to the sound.

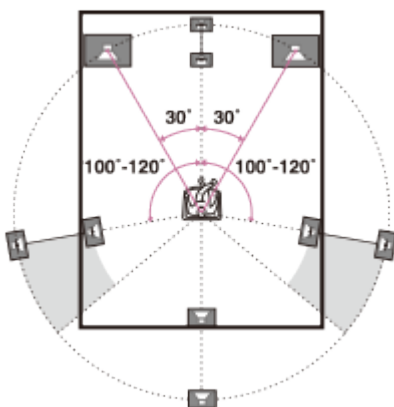

7.1-channel speaker placement

Place the surround back speakers as shown in the illustration below. The angles shown by **A** should be the same.

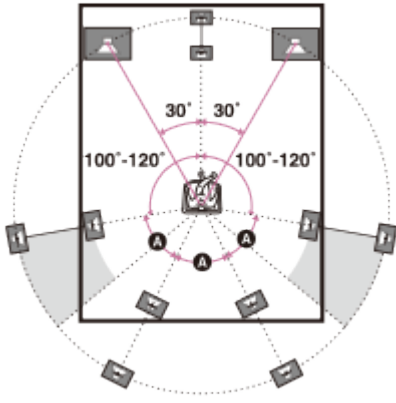

Hint

- As the subwoofer does not emit highly directional signals, you can place it wherever you want.

[14] Preparation | 1. Installing speakers

Installing 7.1-channel speaker system using front high speakers

You can enjoy vertical sound effects by connecting additional two front high speakers.

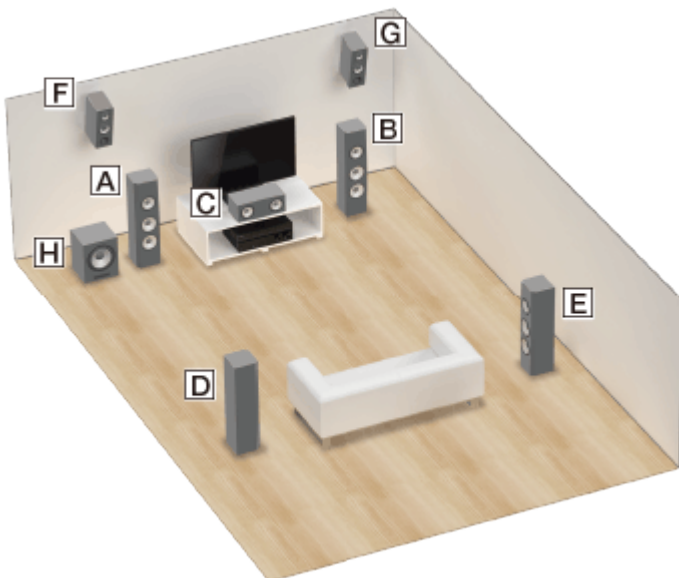

- A Front speaker (Left)**
- B Front speaker (Right)**
- C Center speaker**
- D Surround speaker (Left)**
- E Surround speaker (Right)**
- F Front high speaker (Left)**

G Front high speaker (Right)

H Subwoofer

1. Place the front high speakers at an angle between 25° and 35°.

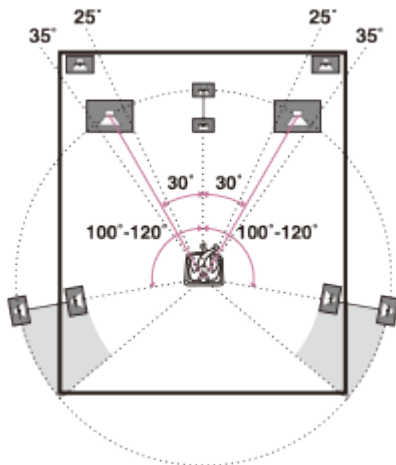

2. Place the front high speakers at height angle of $20^\circ \pm 5^\circ$.

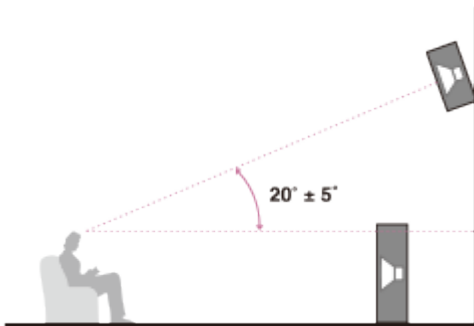

Hint

- As the subwoofer does not emit highly directional signals, you can place it wherever you want.

[15] Preparation | 1. Installing speakers

Installing 5.1-channel speaker system

To fully enjoy theater-like multi-channel surround sound, you need five speakers (two front speakers, a center speaker, and two surround speakers) and a subwoofer.

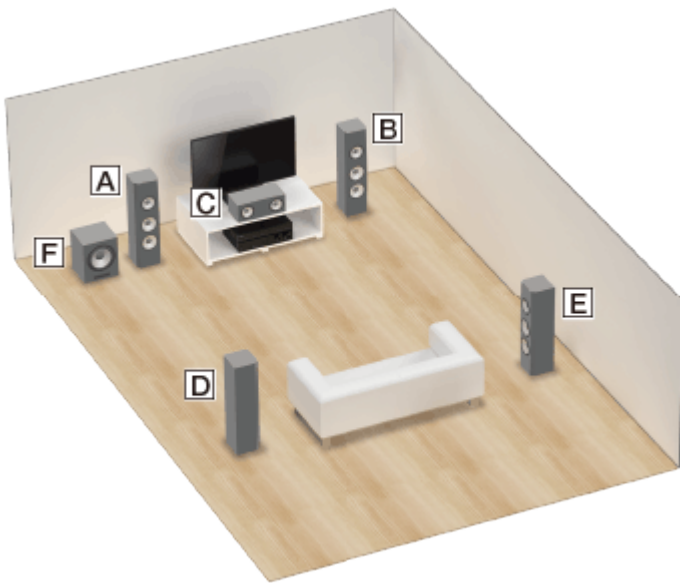

- A Front speaker (Left)**
- B Front speaker (Right)**
- C Center speaker**
- D Surround speaker (Left)**
- E Surround speaker (Right)**
- F Subwoofer**

Hint

- As the subwoofer does not emit highly directional signals, you can place it wherever you want.

[16] Preparation | 1. Installing speakers

Installing speakers in other rooms (Zone 2/Zone 3) (for STR-DN1060 only)

When listening in main zone and Zone 2

If the main zone speakers are connected using a 5.1ch connection, you can also enjoy the audio in another location (“Zone 2”) by connecting additional Zone 2 speakers.

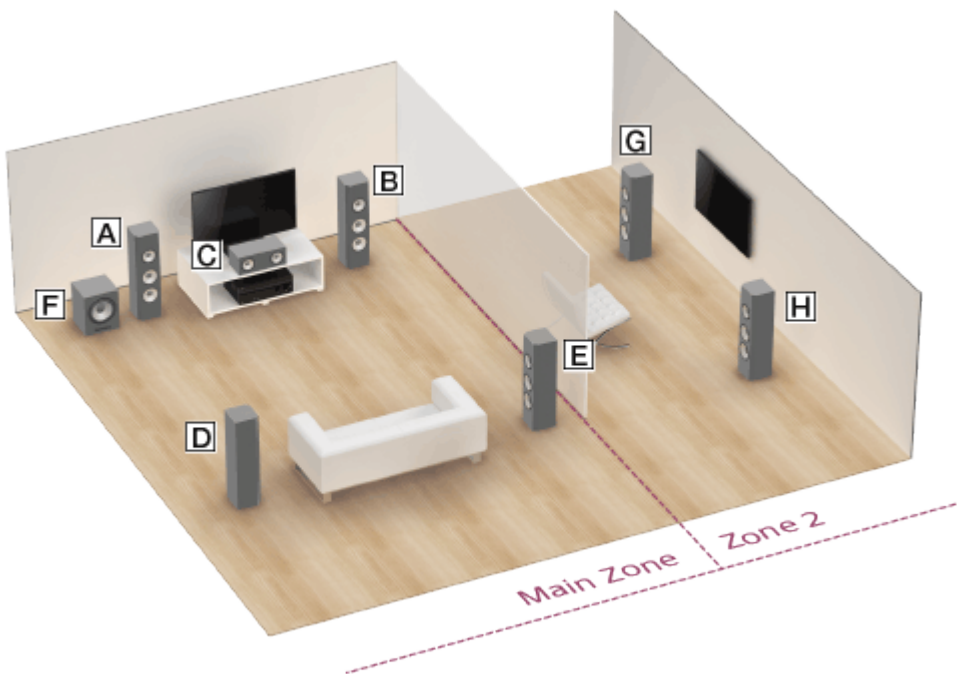

- A Front speaker (Left)**
- B Front speaker (Right)**
- C Center speaker**
- D Surround speaker (Left)**
- E Surround speaker (Right)**
- F Subwoofer**
- G Zone 2 speaker (Left)**
- H Zone 2 speaker (Right)**

Hint

- As the subwoofer does not emit highly directional signals, you can place it wherever you want.

When listening in main zone, Zone 2 and Zone 3

If the main zone speakers are connected using a 3.1ch connection, you can also enjoy audio in two or more locations (“Zone 2” and “Zone 3”) by connecting additional Zone 2 and Zone 3 speakers.

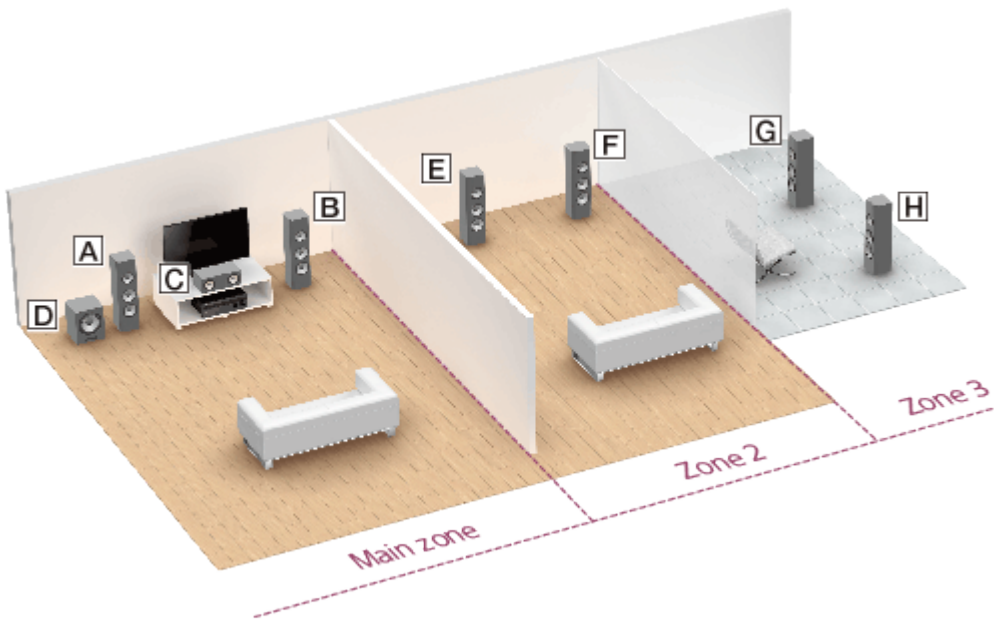

- A Front speaker (Left)**
- B Front speaker (Right)**
- C Center speaker**
- D Subwoofer**
- E Zone 2 speaker (Left)**
- F Zone 2 speaker (Right)**
- G Zone 3 speaker (Left)**
- H Zone 3 speaker (Right)**

[17] Preparation | 2. Connecting speakers

Connecting speakers

Connect each speaker as illustrated below.

Be sure to disconnect the AC power cord (mains lead) before connecting cables.

For details on how to connect speaker cables to the receiver, see "[How to connect speaker cables.](#)"

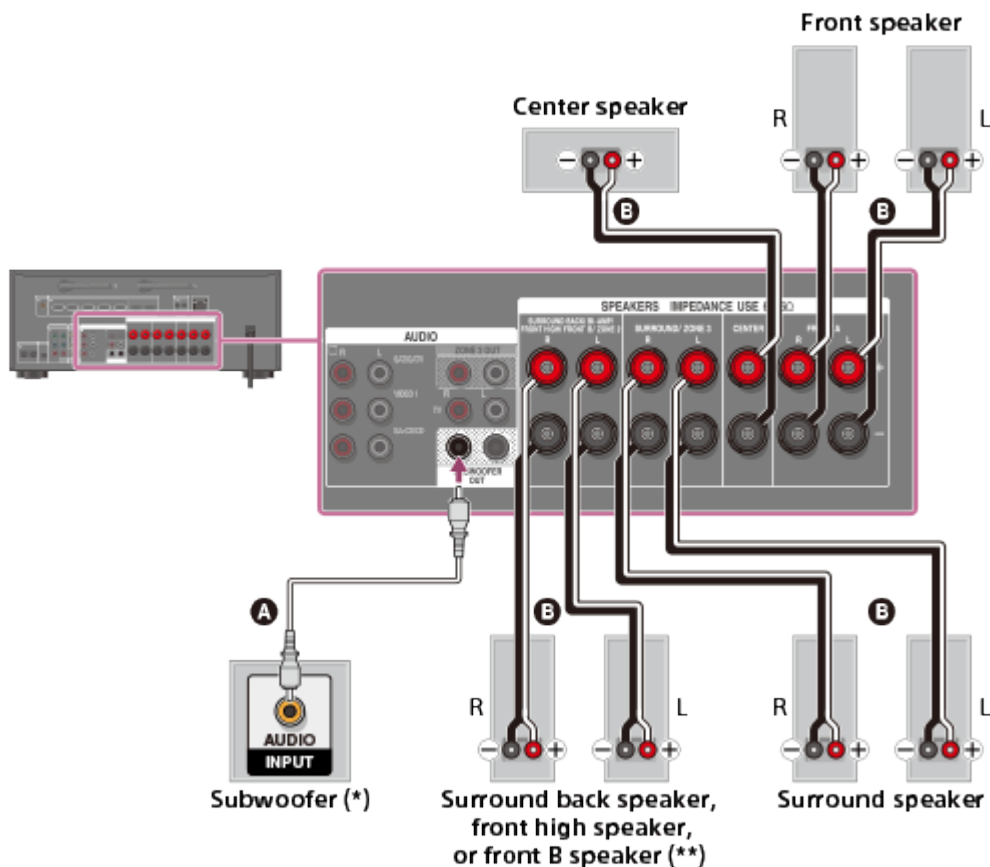

A Monaural audio cable (not supplied)

B Speaker cable (not supplied)

* If you connect a subwoofer with an auto standby function, turn off this function when watching movies. If the auto standby function is turned on, it switches to standby mode automatically based on the level of the input signal to the subwoofer, and the sound may not be output.

** Notes on connections to the SPEAKERS SURROUND BACK/BI-AMP/FRONT HIGH/FRONT B terminals

- If connecting only one surround back speaker, connect it to the L (+/–) terminals.
- If you have an additional front speaker system, connect it to these terminals. In this case, perform the following procedure:
 1. Select [Speaker Pattern] in the Speaker Settings menu, then select one of the following speaker patterns displayed on the TV screen: 3/2.1, 3/2, 2/2.1, 2/2, 3/0.1, 3/0, 2/0.1 or 2/0, and select [Save].
 2. Set [Sur Back SP Assign] in the Speaker Settings menu to [Front B].

You can select the front speaker system you want by using the SPEAKERS button on the receiver.

- You can connect the front speakers to this terminal using a bi-amplifier connection. In this case, set [Sur Back SP Assign] in the Speaker Settings menu to [Bi-Amp].

Note

- After you have installed and connected your speakers, be sure to select the speaker pattern you want using [Speaker Pattern] in the Speaker Settings menu.

Connecting the speakers in Zone 2 and/or Zone 3 (for STR-DN1060 only)

You can enjoy sound from a device connected to the receiver in a zone other than the main zone. For example, it is possible to play a CD in Zone 2 while playing a DVD in the main zone.

Place the speakers in Zone 2 and connect them to SPEAKERS SURROUND BACK/BI-AMP/FRONT HIGH/FRONT B/ZONE 2 terminals as illustrated below.

Be sure to disconnect the AC power cord (mains lead) before connecting cables. For details on how to connect speaker cables to the receiver, see "[How to connect speaker cables.](#)"

Connecting the speakers in Zone 2

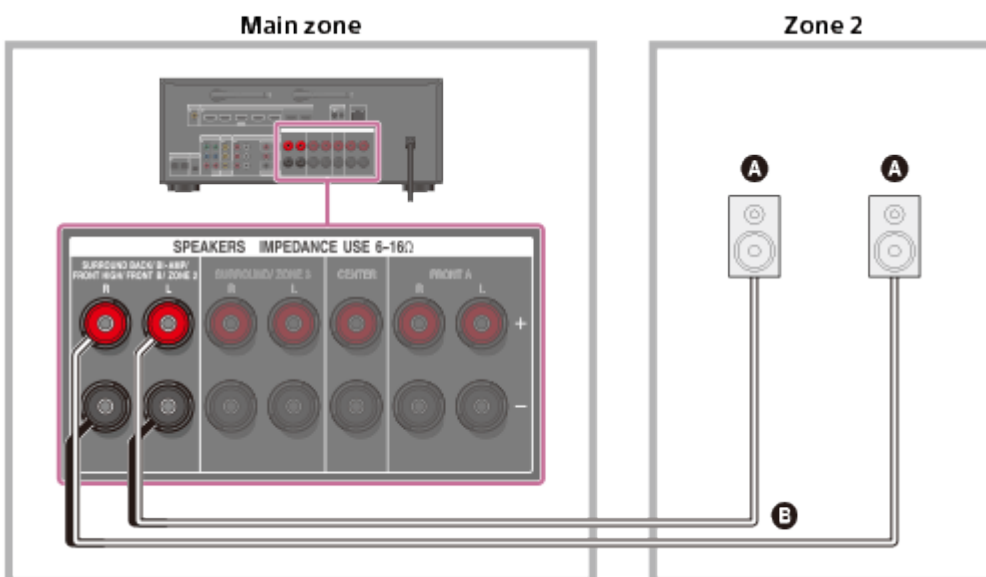

- A** Speakers
- B** Speaker cable (not supplied)

Note

- When using this Zone 2 connection, you need to set up the SPEAKERS SURROUND BACK/BI-AMP/FRONT HIGH/FRONT B/ZONE 2 terminals.
- Only audio signals from [USB], [Bluetooth] (while in BLUETOOTH RX mode only), [Home Network], [Music Services], [FM TUNER] and audio signals input from AUDIO IN jacks are output to the Zone 2 speakers.
- External digital input from OPTICAL IN, COAXIAL IN, HDMI IN jacks and Screen mirroring cannot be output to Zone 2.

Connecting the speakers in Zone 3

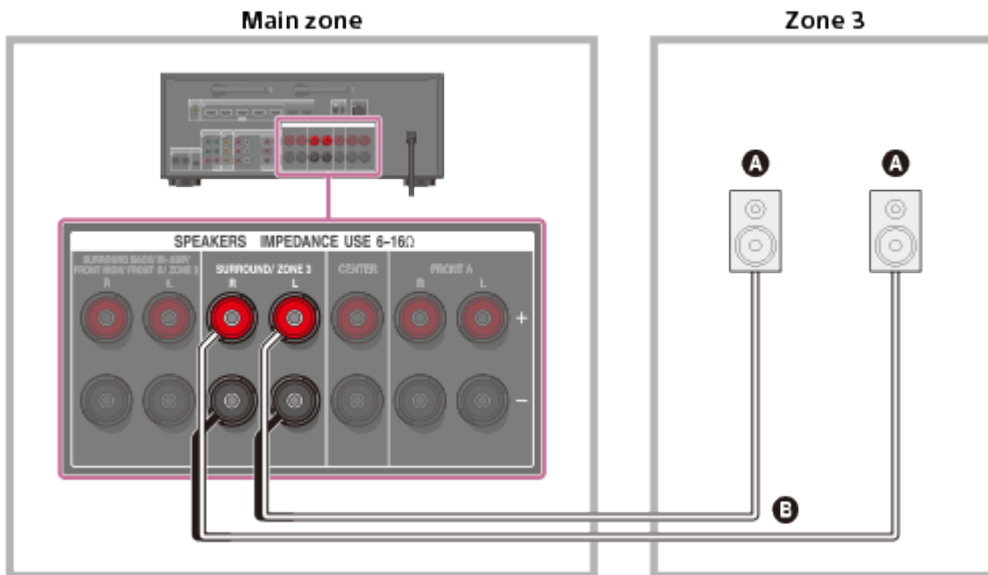

- A Speakers**
- B Speaker cable (not supplied)**

Note

- When using this Zone 3 connection, you need to set up the SPEAKERS SURROUND/ZONE 3 terminals.
- Only audio signals from [USB], [Bluetooth] (while in BLUETOOTH RX mode only), [Home Network], [Music Services], [FM TUNER] and audio signals input from AUDIO IN jacks are output to the Zone 3 speakers.
- External digital input from OPTICAL IN, COAXIAL IN, HDMI IN jacks and Screen mirroring cannot be output to Zone 3.

[19] Preparation | 2. Connecting speakers

Bi-amplifier connections

You can enhance the sound quality by connecting different amplifiers to both a tweeter and a woofer, using bi-amplifier connection.

If you are not using surround back speakers or front high speakers, you can connect the front speakers to the SPEAKERS SURROUND BACK/BI-AMP/FRONT HIGH/FRONT B terminals using a bi-amplifier connection.

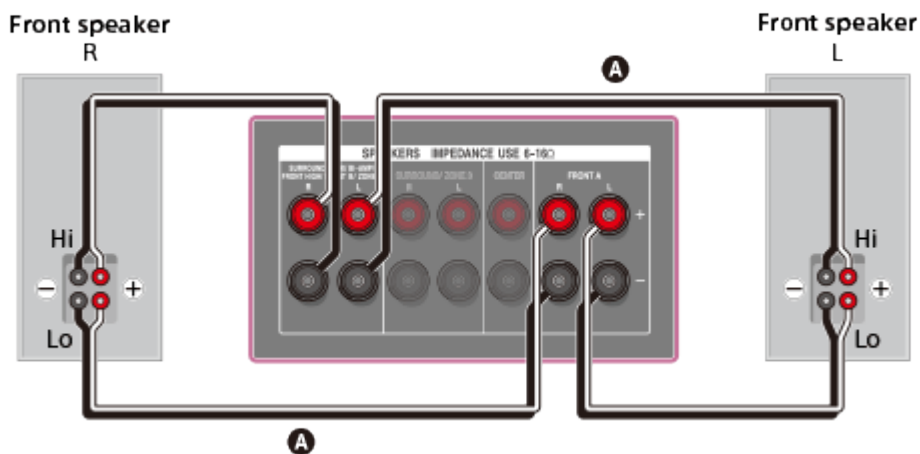

A Speaker cable (not supplied)

Connect the jacks on the Lo (or Hi) side of the front speakers to the SPEAKERS FRONT A terminals, and connect the jacks on the Hi (or Lo) side of the front speakers to the SPEAKERS SURROUND BACK/BI-AMP/FRONT HIGH/FRONT B terminals.

Make sure that metal fittings of Hi/Lo attached to the speakers have been removed from the speakers to avoid receiver malfunction.

After you have made the bi-amplifier connection, set [Sur Back SP Assign] in the Speaker Settings menu to [Bi-Amp].

Note

- You can only set [Sur Back SP Assign] if the speaker pattern is set to a setting that does not have surround back and front high speakers.

[20] Preparation | 3. Connecting a TV

Connecting a TV (for STR-DN1060)

Connect a TV to the HDMI OUT or MONITOR OUT jack. You can operate this receiver using the menu on the TV screen when you connect the TV to the HDMI OUT A (TV) jack.

Be sure to disconnect the AC power cord (mains lead) before connecting cables.

Connecting a TV incompatible with the Audio Return Channel (ARC) function via an HDMI connection

Solid lines show recommended connections and the dashed lines show alternative connections for audio signals. It is not necessary to connect all the cables. HDMI connection for audio/video signals is required.

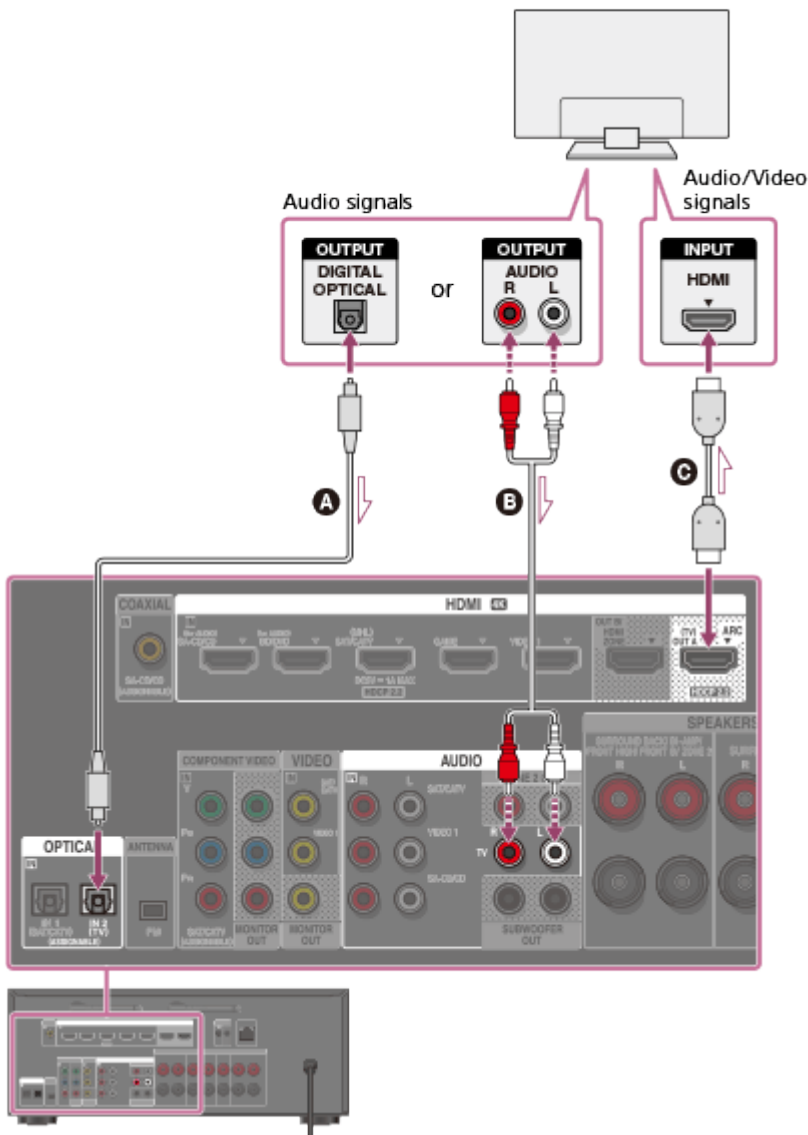

- A** Optical digital cable (not supplied)
- B** Audio cable (not supplied)
- C** HDMI cable (not supplied)

Sony recommends that you use an HDMI-authorized cable or HDMI cable made by Sony.

Connecting a TV compatible with the Audio Return Channel (ARC) function via an HDMI connection

With just one HDMI cable connection, you can listen to the TV audio from the speakers connected to the receiver while the receiver sends audio and video to the TV.

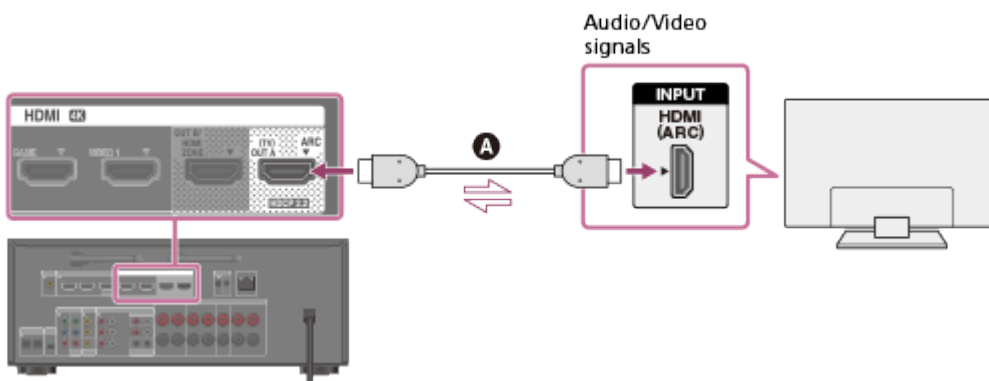

- A** HDMI cable (not supplied)

Sony recommends that you use an HDMI-authorized cable or HDMI cable made by Sony.

Note

- For this connection, you need to turn the Control for HDMI function on. Press HOME to display the home menu, select [Setup] - [HDMI Settings], and set [Control for HDMI] to [On].

Hint

- If the HDMI jack of the TV (labeled "ARC") is already connected to another device, disconnect the device and connect the receiver.

Connecting a TV and a projector

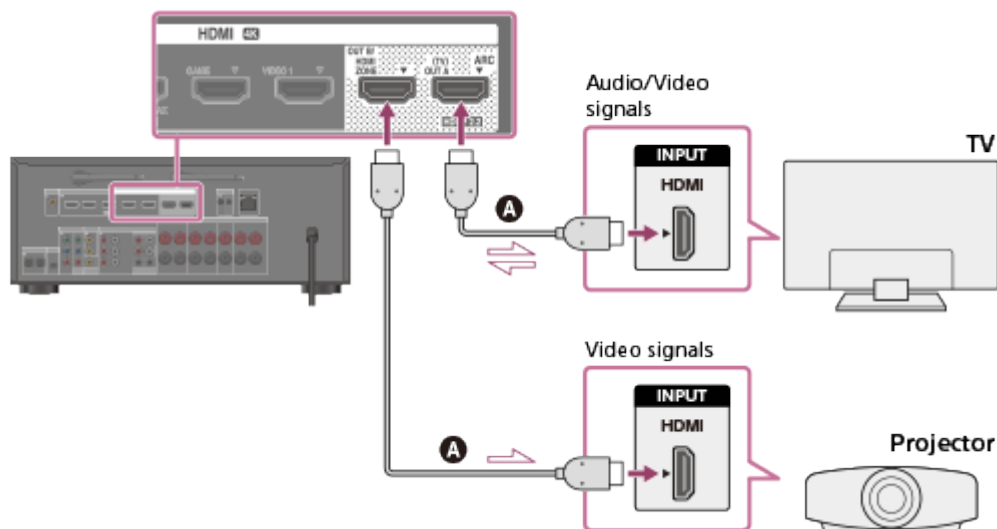

A HDMI cable (not supplied)

Sony recommends that you use an HDMI-authorized cable or HDMI cable made by Sony.

Note

- For this connection, set [HDMI Out B Mode] in the HDMI Settings menu to [Main].

Connecting a TV without HDMI jacks

Solid lines show recommended connections and the dashed lines show alternative connections for both video and audio signals. It is not necessary to connect all the cables.

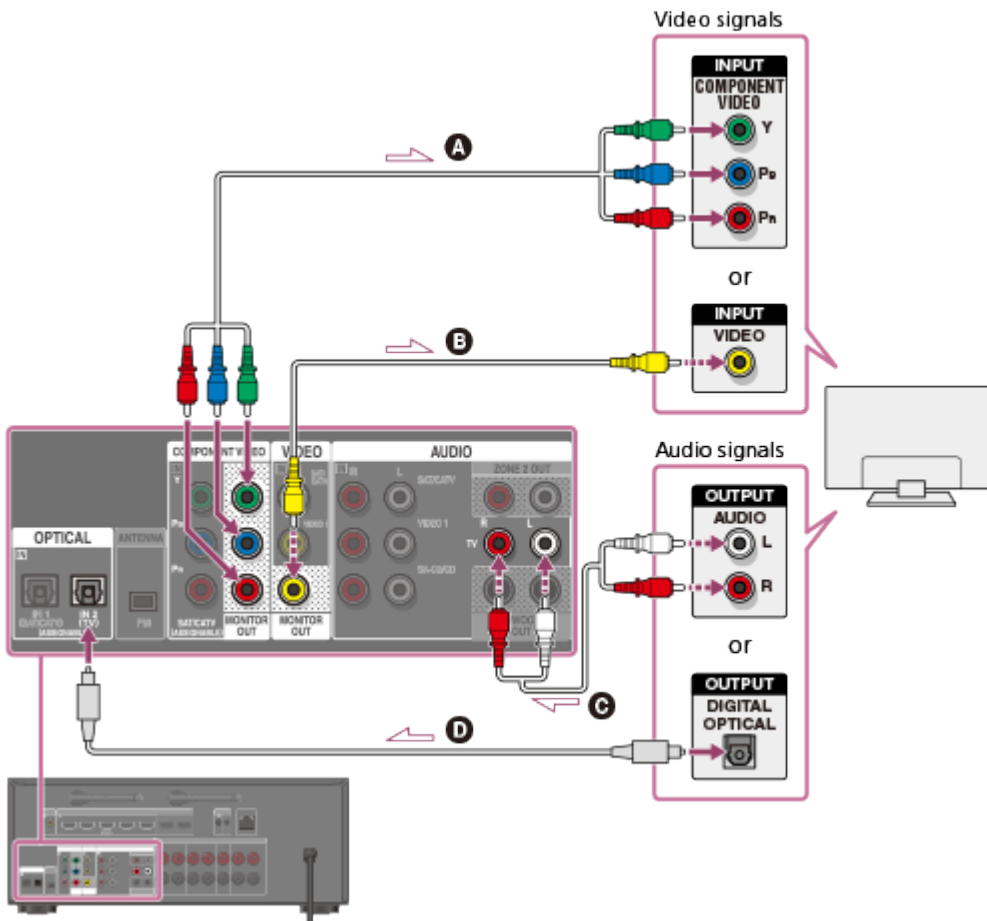

- A Component video cable (not supplied)**
- B Video cable (not supplied)**
- C Audio cable (not supplied)**
- D Optical digital cable (not supplied)**

Note

- Connect a TV monitor or a projector to the HDMI OUT A (TV), HDMI OUT B/HDMI ZONE or MONITOR OUT jack on the receiver.
- Depending on the status of the connection between the TV and the antenna (aerial), the image on the TV screen may be distorted. If this is the case, place the antenna (aerial) farther away from the receiver.
- When connecting an optical digital cable, insert the plugs straight until they click into place.
- Do not bend or tie optical digital cables.

Hint

- All of the digital audio jacks are compatible with 32 kHz, 44.1 kHz, 48 kHz and 96 kHz sampling frequencies.
- When connecting a TV to the receiver via the TV IN jacks of the receiver, set the sound output jack of the TV to [Fixed] if it can be switched between either [Fixed] or [Variable].

Connecting a TV (for STR-DN860)

Connect a TV to the HDMI TV OUT or MONITOR OUT jack. You can operate this receiver using the menu on the TV screen when you connect the TV to the HDMI TV OUT jack. Be sure to disconnect the AC power cord (mains lead) before connecting cables.

Connecting a TV incompatible with the Audio Return Channel (ARC) function via an HDMI connection

Solid lines show recommended connections and the dashed lines show alternative connections for audio signals. It is not necessary to connect all the cables. HDMI connection for audio/video signals is required.

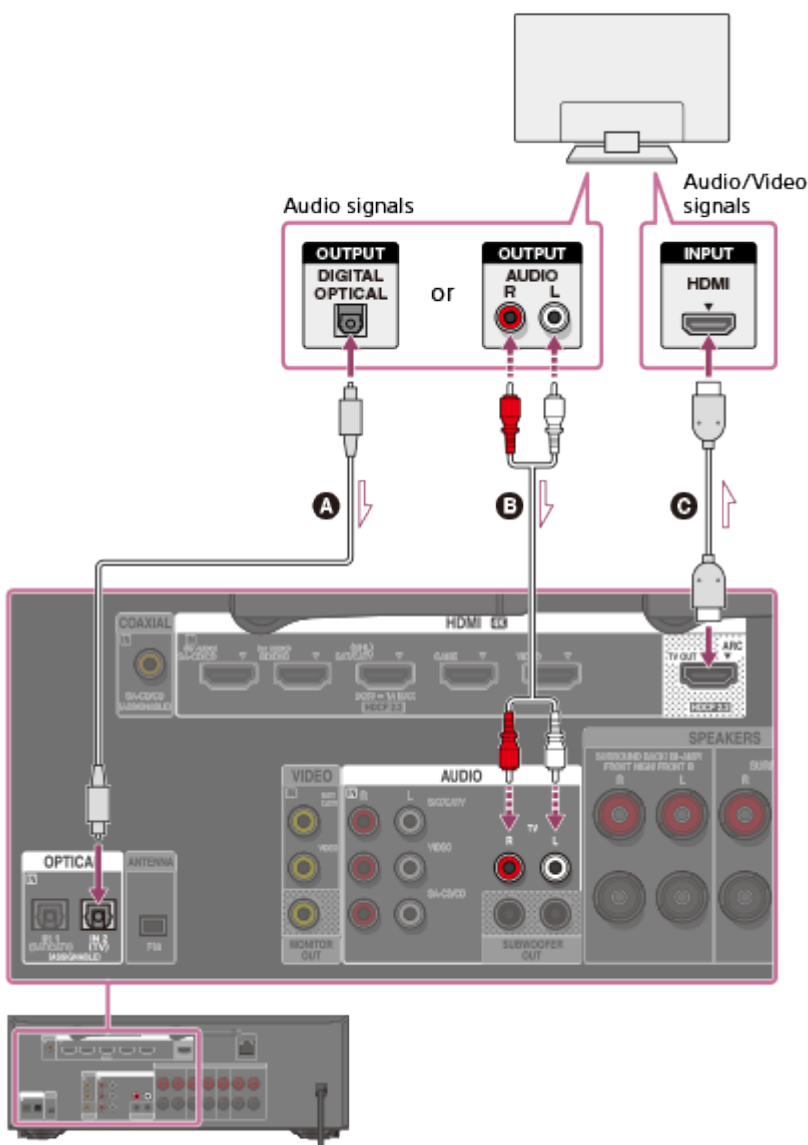

- A** Optical digital cable (not supplied)
- B** Audio cable (not supplied)
- C** HDMI cable (not supplied)

Sony recommends that you use an HDMI-authorized cable or HDMI cable made by Sony.

Connecting a TV compatible with the Audio Return Channel (ARC) function via an HDMI connection

With just one HDMI cable connection, you can listen to the TV audio from the speakers connected to the receiver while the receiver sends audio and video to the TV.

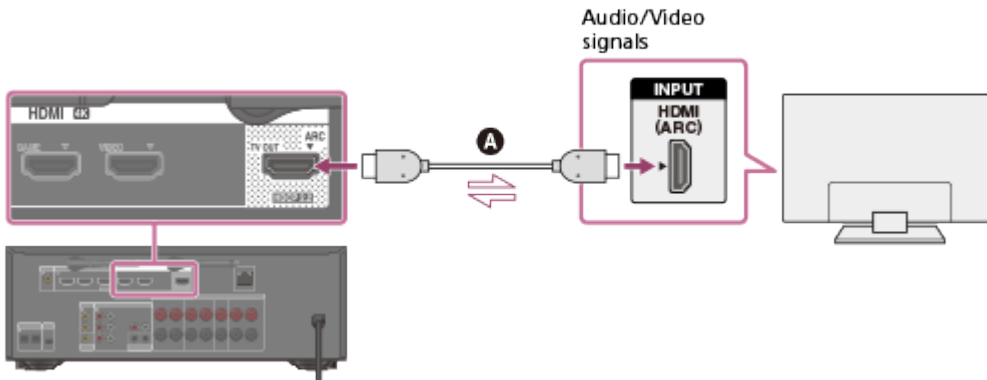

A HDMI cable (not supplied)

Sony recommends that you use an HDMI-authorized cable or HDMI cable made by Sony.

Note

- For this connection, you need to turn the Control for HDMI function on. Press HOME to display the home menu, select [Setup] - [HDMI Settings], and set [Control for HDMI] to [On].

Hint

- If the HDMI jack of the TV (labeled "ARC") is already connected to another device, disconnect the device and connect the receiver.

Connecting a TV without HDMI jacks

Solid lines show recommended connections and the dashed lines show alternative connections for audio signals. It is not necessary to connect all the cables. Connections for video signals are required.

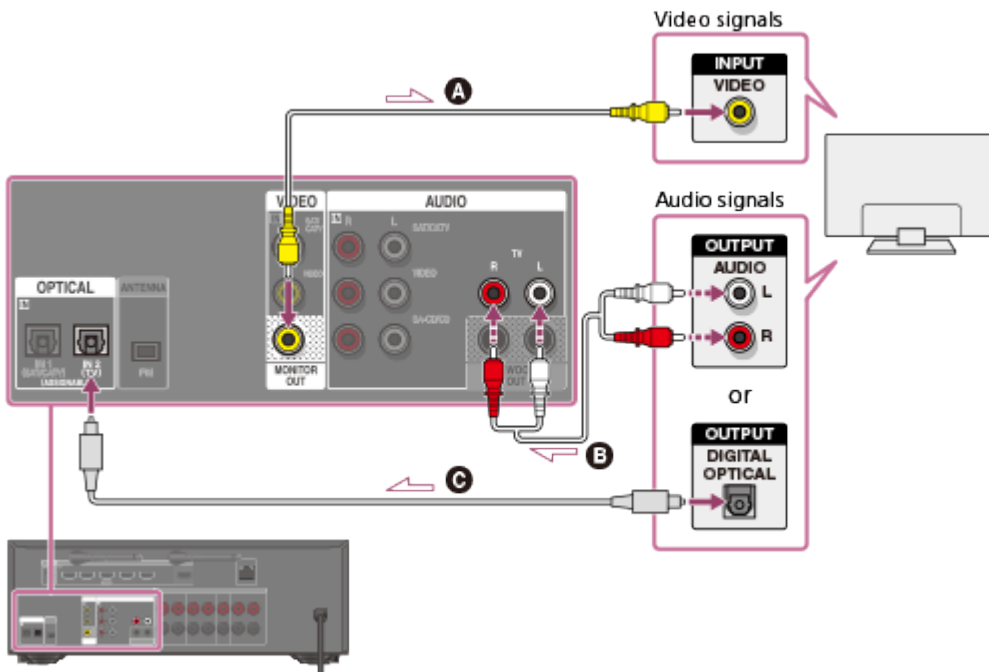

- A** Video cable (not supplied)
- B** Audio cable (not supplied)
- C** Optical digital cable (not supplied)

Note

- Connect a TV monitor or a projector to the HDMI TV OUT or MONITOR OUT jack on the receiver.
- Depending on the status of the connection between the TV and the antenna (aerial), the image on the TV screen may be distorted. If this is the case, place the antenna (aerial) farther away from the receiver.
- When connecting an optical digital cable, insert the plugs straight until they click into place.
- Do not bend or tie optical digital cables.

Hint

- All of the digital audio jacks are compatible with 32 kHz, 44.1 kHz, 48 kHz and 96 kHz sampling frequencies.
- When connecting a TV to the receiver via the TV IN jacks of the receiver, set the sound output jack of the TV to [Fixed] if it can be switched between either [Fixed] or [Variable].

[22] Preparation | 3. Connecting a TV

Connecting a 4K TV

All HDMI jacks on the rear panel support 4K resolution. The HDMI jacks designated as being “HDCP 2.2” (HDMI IN SAT/CATV (MHL), HDMI OUT A (TV) (*), HDMI TV OUT (**)) support

High-bandwidth Digital Content Protection System Revision 2.2 (HDCP 2.2).

To watch HDCP 2.2 protected content such as 4K content, connect these HDMI jacks to jacks that support HDCP 2.2 on the TV and player. For details on whether the TV and player are equipped with HDCP 2.2-compatible HDMI jack, refer to the operating instructions of the connected device.

* For STR-DN1060 only.

** For STR-DN860 only.

When an HDCP 2.2 compatible HDMI jack on the TV is labeled “ARC” (*)

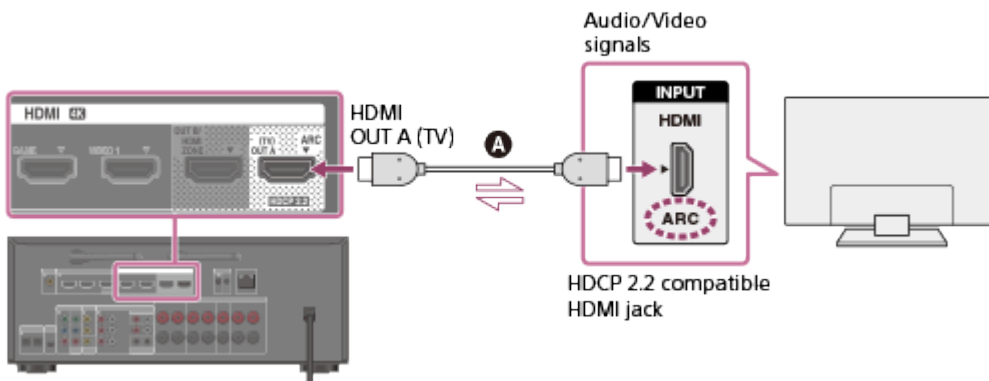

A HDMI cable (not supplied)

* The ARC (Audio Return Channel) function sends digital sound from a TV to the receiver using only an HDMI cable.

When you want to watch HDCP 2.2 protected content and the non-HDCP 2.2 compatible HDMI jack on the TV is labeled “ARC”

If the HDMI jack on the TV is labeled ARC and is not HDCP 2.2 compatible, connect the receiver to the HDCP 2.2 compatible HDMI jack on the TV using an HDMI cable. Then, connect an optical digital cable to the optical output jack of the TV to listen to digital sound.

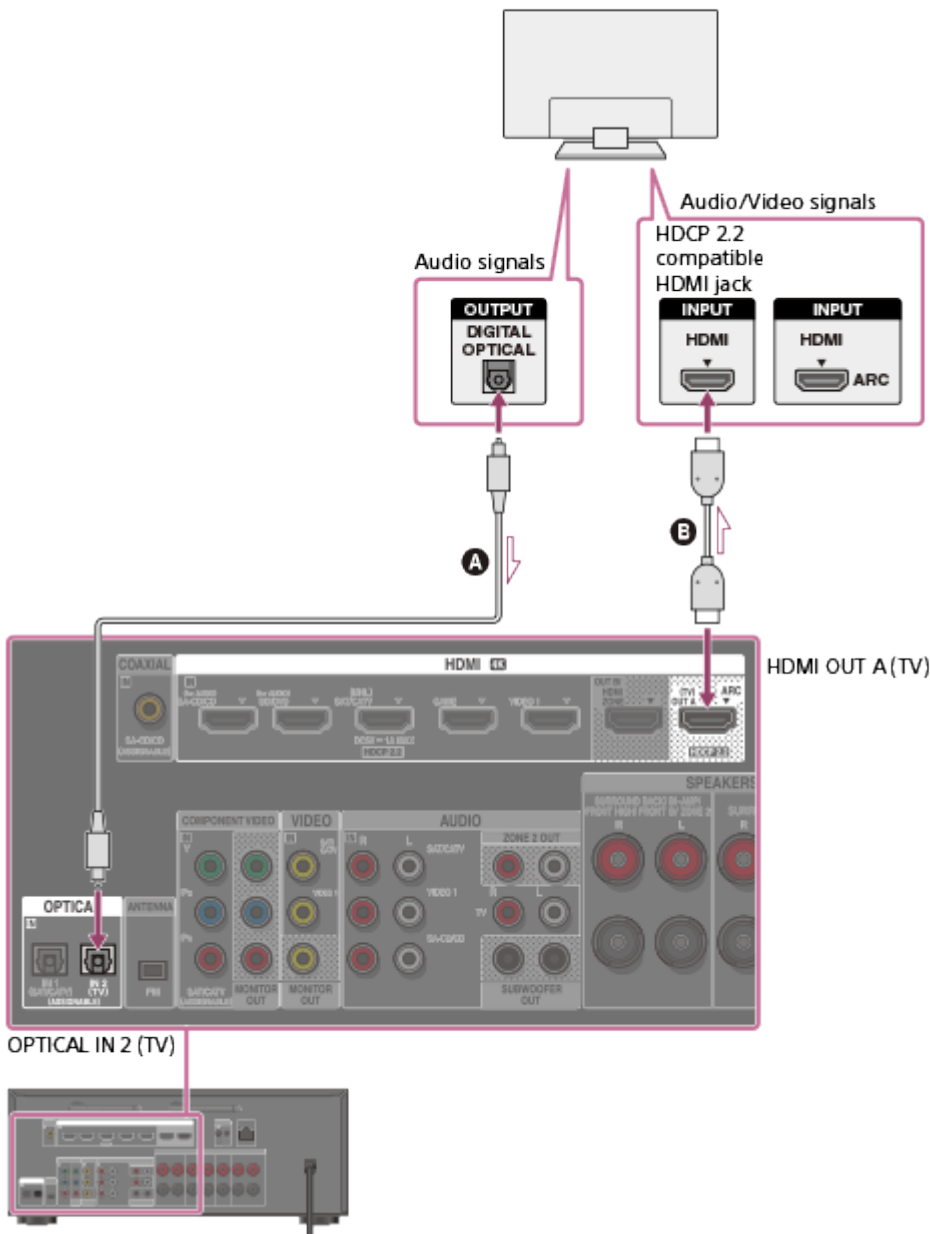

- A** Optical digital cable (not supplied)
- B** HDMI cable (not supplied)

[23] Preparation | 3. Connecting a TV

Notes on connecting cables

- Be sure to disconnect the AC power cord (mains lead) before connecting cables.
- It is not necessary to connect all of the cables. Connect cables according to the availability of jacks on the connected device.
- Use a High Speed HDMI cable. 1080p, Deep Color (Deep Colour), 4K or 3D images may not be displayed properly if you use a Standard HDMI cable.
- We do not recommend using an HDMI-DVI conversion cable. If you connect an HDMI-DVI conversion cable to a DVI-D device, the sound and/or image may be lost. Connect

separate audio cables or digital connecting cables, then reassign the input jacks if the sound is not output correctly.

- When connecting optical digital cables, insert the plugs straight until they click into place.
- Do not bend or tie optical digital cables.

Hint

- All of the digital audio jacks are compatible with 32 kHz, 44.1 kHz, 48 kHz and 96 kHz sampling frequencies.

If you want to connect several digital devices, but cannot find an unused input

In this case, reassign the input jacks.

[24] Preparation | 3. Connecting a TV

About HDMI connections

High-Definition Multimedia Interface (HDMI) is an interface that transmits video and audio signals in digital format. Connecting Sony “BRAVIA” Sync-compatible devices using HDMI cables simplifies operations.

HDMI features

- Digital audio signals transmitted by HDMI can be output from the speakers connected to the receiver. This signal supports Dolby Digital, DTS, DSD, and Linear PCM.
- The receiver can receive Multi Channel Linear PCM (up to 8 channels) with a sampling frequency of 192 kHz or less via an HDMI connection.
- This receiver supports High Bitrate Audio (DTS-HD Master Audio, Dolby TrueHD), Deep Color (Deep Colour), “x.v.Color (x.v.Colour),” and 4K or 3D transmission.
- To enjoy 3D images, connect a 3D-compatible TV and video device (Blu-ray Disc player, Blu-ray Disc recorder, PlayStation 4, etc.) to the receiver using High Speed HDMI cables, put on 3D glasses, and then play 3D-compatible content.
- To enjoy 4K (HDMI IN SA-CD/CD, BD/DVD, SAT/CATV (MHL), GAME, VIDEO 1 (*), VIDEO (**)) images, connect a 4K-compatible TV or video device (Blu-ray Disc player, etc.) to the receiver using High Speed HDMI cables, and then play 4K-compatible content.
- The HDMI jacks designated as being “HDCP 2.2” support High-bandwidth Digital Content Protection System Revision 2.2 (HDCP 2.2). Connect these HDMI jacks to jacks that support HDCP 2.2 on the TV and device. Refer to the operating instructions of the connected device for details.

* For STR-DN1060 only.

** For STR-DN860 only.

Note

- Depending on the TV or video device, 4K or 3D images may not be displayed. Check the HDMI video formats supported by the receiver.
- Refer to the operating instructions of each connected device for details.

[25] Preparation | 4. Connecting audio-visual devices and the antennas (aerials)

Connecting devices with HDMI jacks (for STR-DN1060)

Connect devices to the receiver as illustrated below. Before connecting cables, be sure to disconnect the AC power cord (mains lead).

The HDMI jacks designated as being “HDCP 2.2” (HDMI IN SAT/CATV (MHL), HDMI OUT A (TV)) support High-bandwidth Digital Content Protection System Revision 2.2 (HDCP 2.2). To watch content protected by HDCP 2.2, such as 4K content, connect these HDMI jacks to jacks that support HDCP 2.2 on the TV and player. Refer to the operating instructions of the connected device for details.

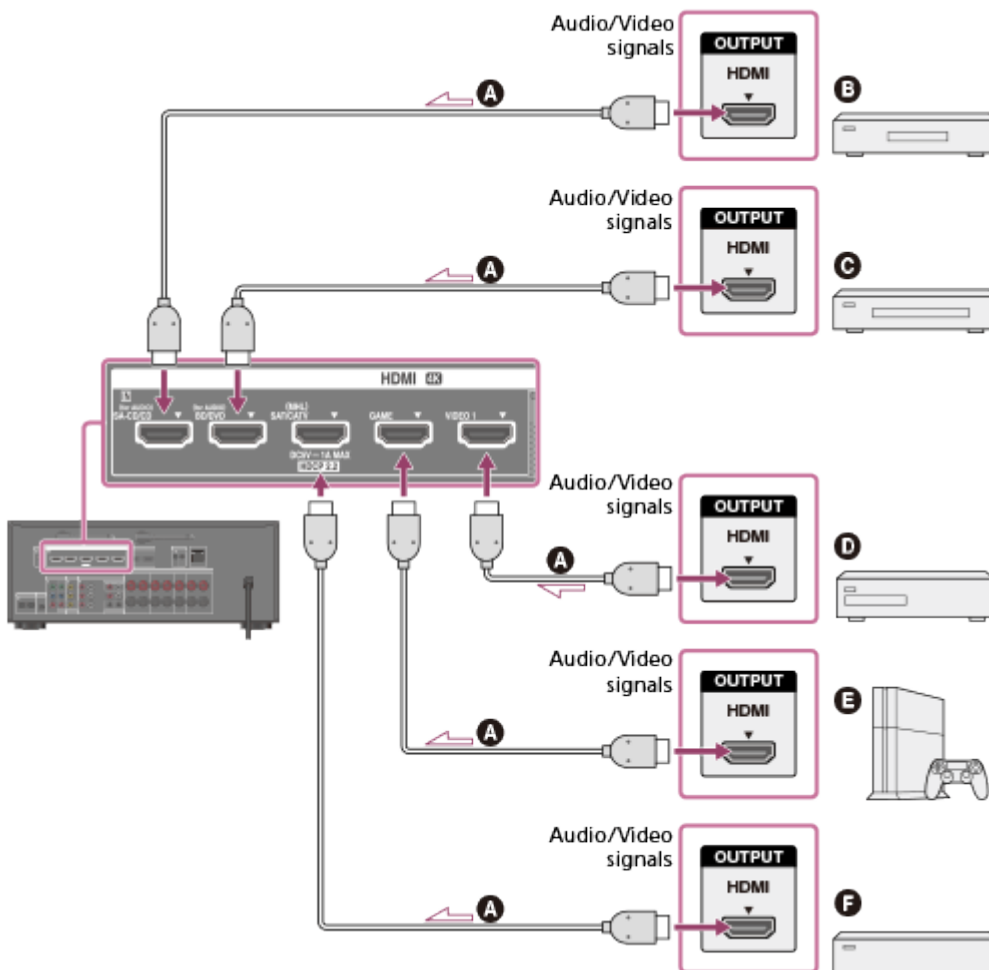

A HDMI cable (not supplied)

Sony recommends that you use an HDMI-authorized cable or HDMI cable made by Sony.

- Ⓑ Super Audio CD player, CD player
- Ⓒ Blu-ray Disc player, DVD player
- Ⓓ DVD recorder
- Ⓔ Game console such as PlayStation4
- Ⓕ Cable box or satellite box

Hint

- This HDMI connection is an example. You can connect each HDMI device to any HDMI input, including the HDMI input on the front panel.
- The BD/DVD and SA-CD/CD inputs have better sound quality. When you need a higher sound quality, connect your device to these jacks and select them as the input.
- The image quality depends on the connecting jack. We recommend that you connect your devices via an HDMI connection if they have HDMI jacks.

[26] Preparation | 4. Connecting audio-visual devices and the antennas (aerials)

Connecting devices with HDMI jacks (for STR-DN860)

Connect devices to the receiver as illustrated below. Before connecting cables, be sure to disconnect the AC power cord (mains lead).

The HDMI jacks designated as being “HDCP 2.2” (HDMI IN SAT/CATV (MHL), HDMI TV OUT) support High-bandwidth Digital Content Protection System Revision 2.2 (HDCP 2.2). To watch content protected by HDCP 2.2, such as 4K content, connect these HDMI jacks to jacks that support HDCP 2.2 on the TV and player. Refer to the operating instructions of the connected device for details.

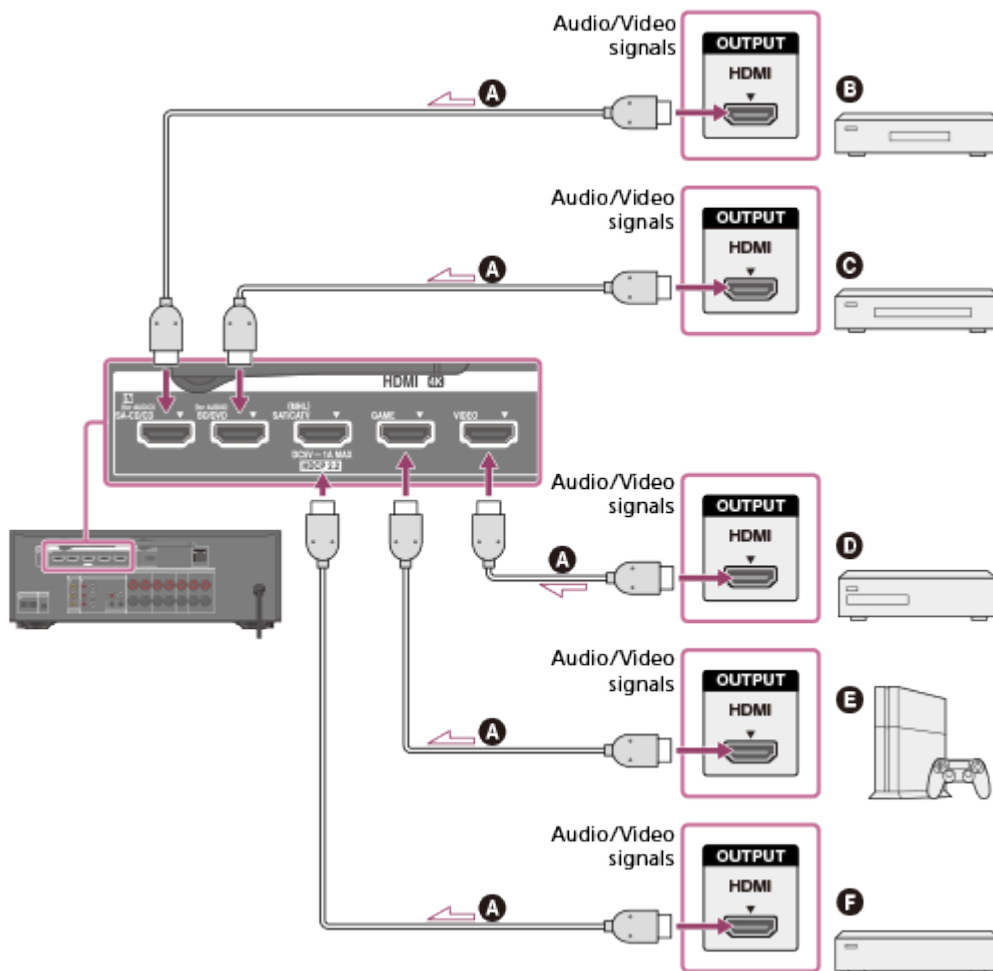

A HDMI cable (not supplied)

Sony recommends that you use an HDMI-authorized cable or HDMI cable made by Sony.

B Super Audio CD player, CD player

C Blu-ray Disc player, DVD player

D DVD recorder

E Game console such as PlayStation4

F Cable box or satellite box

Hint

- This HDMI connection is an example. You can connect each HDMI device to any HDMI input, including the HDMI input on the front panel.
- The BD/DVD and SA-CD/CD inputs have better sound quality. When you need a higher sound quality, connect your device to these jacks and select them as the input.
- The image quality depends on the connecting jack. We recommend that you connect your devices via an HDMI connection if they have HDMI jacks.

Connect devices to the receiver as illustrated below.

Solid lines show recommended connections and the dashed lines show alternative connections. It is not necessary to connect all the cables.

Be sure to disconnect the AC power cord (mains lead) before connecting cables.

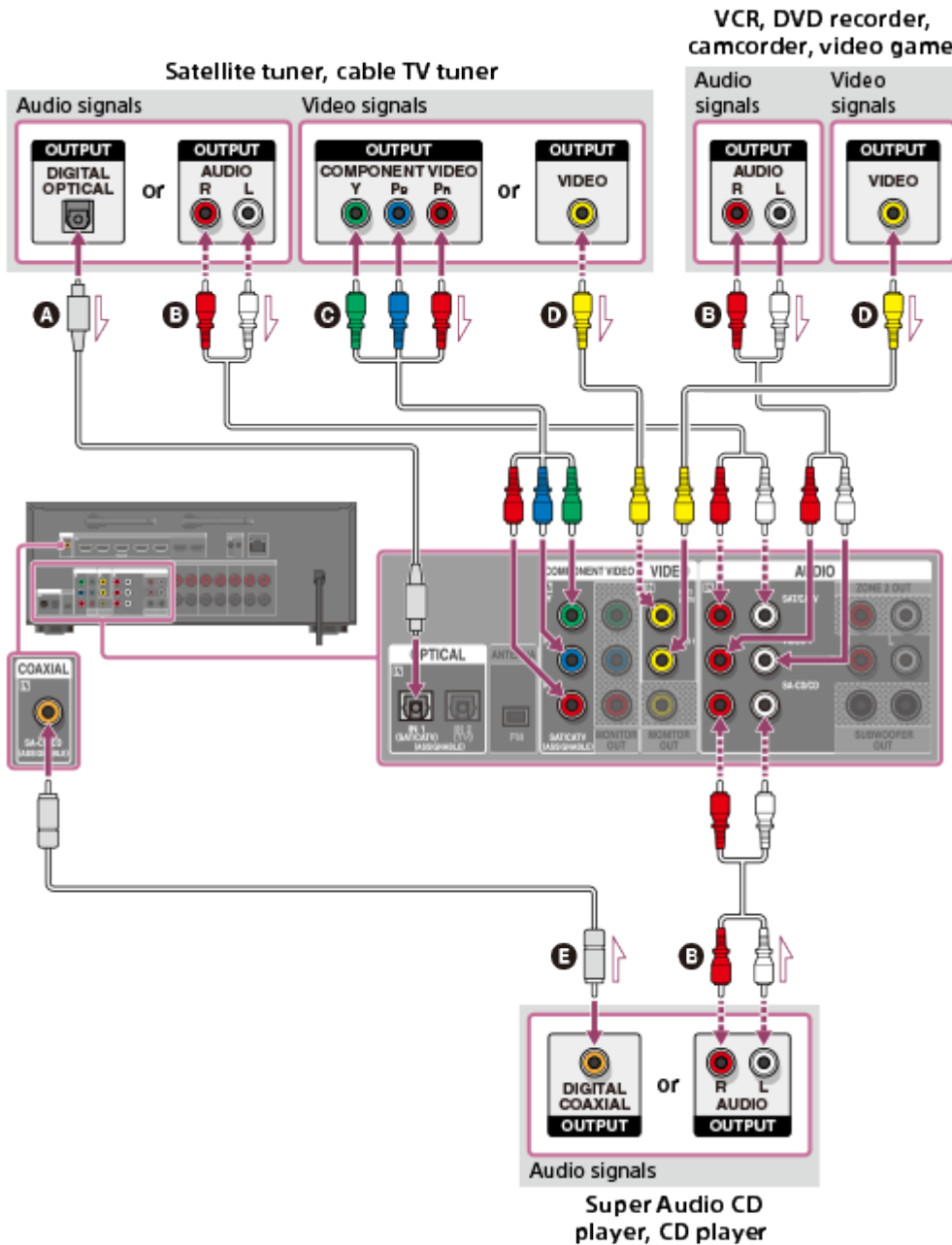

- A** Optical digital cable (not supplied)
- B** Audio cable (not supplied)
- C** Component video cable (not supplied)
- D** Video cable (not supplied)
- E** Coaxial digital cable (not supplied)

Hint

- You can rename each input so that the name can be displayed on the display panel of the receiver. For details, see “[Changing the name for each input \(Name\).](#)”

The image quality depends on the connecting jack. We recommend that you connect your devices via an HDMI connection if they have HDMI jacks.

[28] Preparation | 4. Connecting audio-visual devices and the antennas (aerials)

Connecting devices with jacks other than HDMI jacks (for STR-DN860)

Connect devices to the receiver as illustrated below.
Solid lines show recommended connections and the dashed lines show alternative connections. It is not necessary to connect all the cables. Be sure to disconnect the AC power cord (mains lead) before connecting cables.

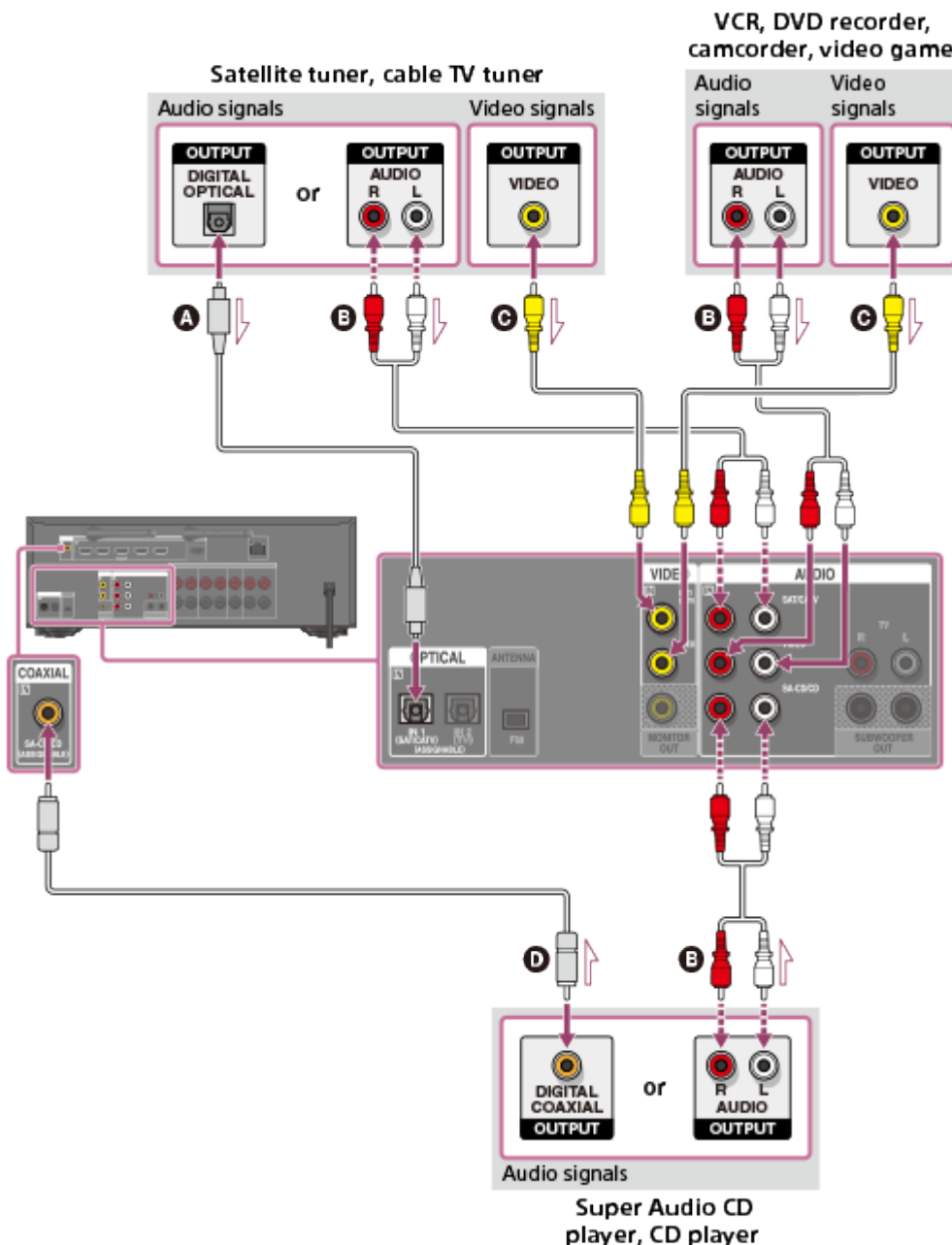

- A Optical digital cable (not supplied)**
- B Audio cable (not supplied)**
- C Video cable (not supplied)**
- D Coaxial digital cable (not supplied)**

Hint

- You can rename each input so that the name can be displayed on the display panel of the receiver. For details, see “[Changing the name for each input \(Name\).](#)”
- The image quality depends on the connecting jack. We recommend that you connect your devices via an HDMI connection if they have HDMI jacks.

[29] Preparation | 4. Connecting audio-visual devices and the antennas (aerials)

Connecting an iPhone, iPod, or USB device

Connect an iPhone, iPod or USB device as illustrated below.

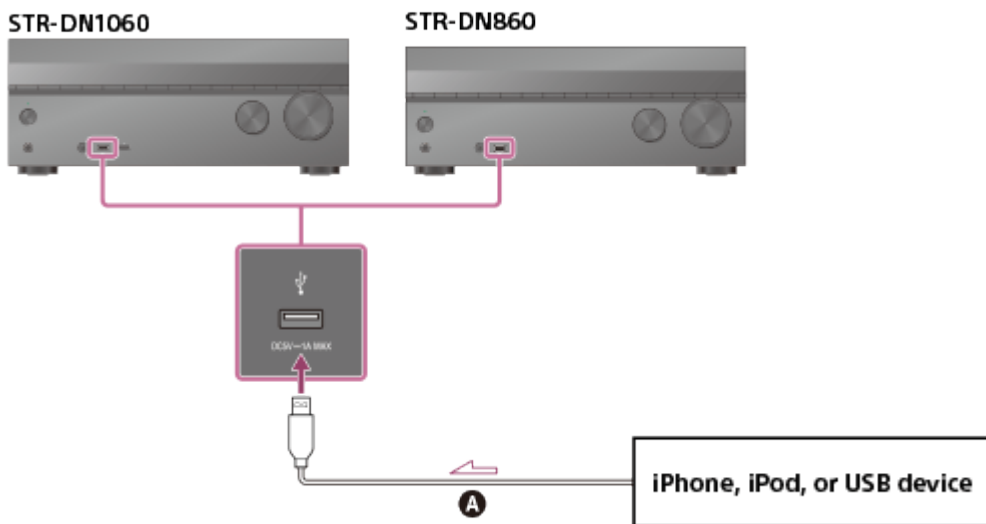

- A USB cable (not supplied)**

Note

- iPad cannot be connected via USB.

[30] Preparation | 4. Connecting audio-visual devices and the antennas (aerials)

Connecting an MHL-compatible mobile device

Connect an MHL-compatible mobile device as illustrated below.

Front (for STR-DN1060 only)

The HDMI/MHL (VIDEO 2 IN) jack supports MHL 2 technology.

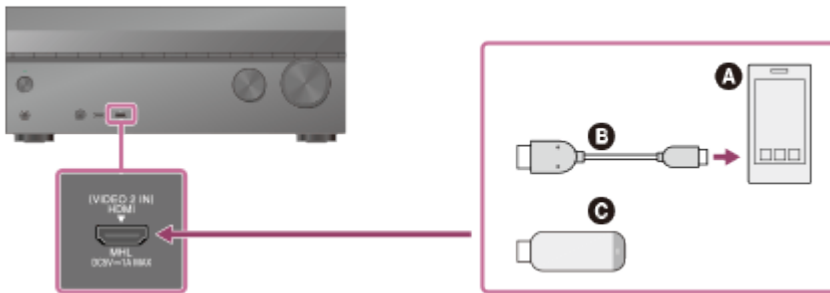

Rear

The HDMI IN SAT/CATV (MHL) jack supports MHL 3 technology.

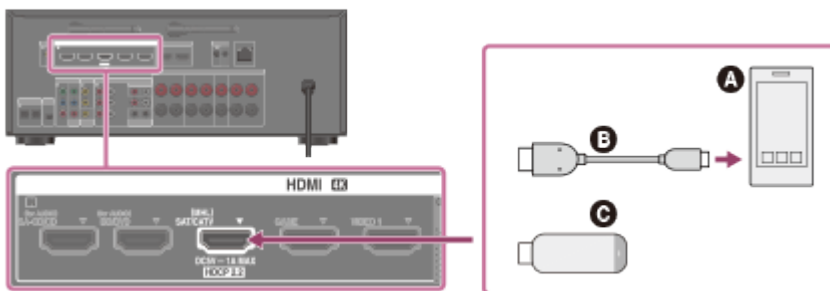

A Mobile device

B MHL cable (not supplied)

We recommend using an MHL 3-compatible cable to connect a mobile device that supports 4K output.

C MHL Direct Attach Device

[31] Preparation | 4. Connecting audio-visual devices and the antennas (aerials)

Connecting the antenna (aerial)

Connect the supplied antenna (aerial) to the receiver as illustrated below.

Be sure to disconnect the AC power cord (mains lead) before connecting the antenna (aerial).

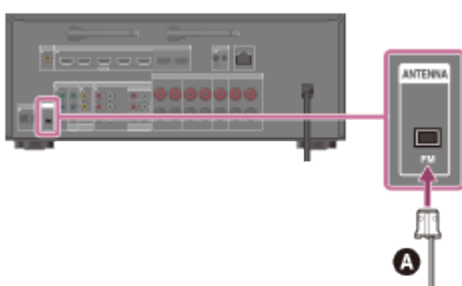

A FM wire antenna (aerial) (supplied)

Note

- Be sure to fully extend the FM wire antenna (aerial).
- After connecting the FM wire antenna (aerial), keep it as horizontal as possible.

[32] Preparation | 4. Connecting audio-visual devices and the antennas (aerials)

Connecting another amplifier in Zone 2 (for STR-DN1060 only)

You can enjoy sound from a device connected to the receiver in a zone other than the main zone. For example, you can watch a DVD in the main zone and listen to a CD in Zone 2.

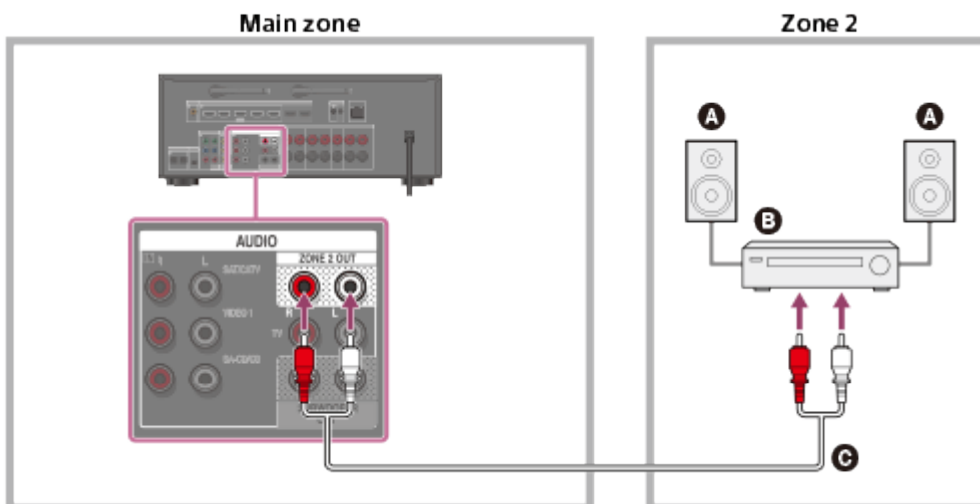

- A** Speakers
- B** Amplifier/receiver
- C** Audio cable (not supplied)

Note

- Only audio signals from [USB], [Bluetooth] (only when in BLUETOOTH RX mode), [Home Network], [Music Services], [FM TUNER] and audio signals input from AUDIO IN jacks are output to the Zone 2 speakers.
- External digital input from OPTICAL IN, COAXIAL IN, HDMI IN jacks and Screen mirroring cannot be output to Zone 2.

[33] Preparation | 4. Connecting audio-visual devices and the antennas (aerials)

Connecting another amplifier or TV in the HDMI zone (for STR-DN1060 only)

HDMI input video/audio signals are output in HDMI zone using the HDMI OUT B/HDMI ZONE jack of the receiver.

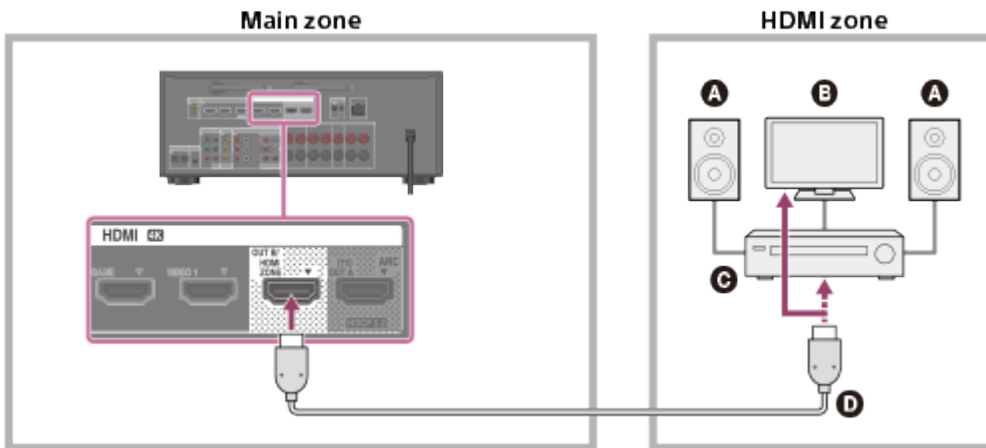

- A Speakers**
- B TV**
- C Amplifier/receiver**
- D HDMI cable (not supplied)**

Note

- To use this connection, set [HDMI Out B Mode] in the HDMI Settings menu to [Zone].

[34] Preparation | 4. Connecting audio-visual devices and the antennas (aerials)

Digital audio formats supported by the receiver

The digital audio formats that this receiver can decode depend on the digital audio output jacks of the connected device. This receiver supports the following audio formats. The words in brackets are those indicated on the display panel.

Dolby Digital [DOLBY D]

Maximum number of channels: 5.1

Connection with the receiver: COAXIAL/OPTICAL, HDMI (*2)

Dolby Digital EX [DOLBY D EX]

Maximum number of channels: 6.1

Connection with the receiver: COAXIAL/OPTICAL, HDMI (*2)

Dolby Digital Plus [DOLBY D +] (*1)

Maximum number of channels: 7.1

Connection with the receiver: HDMI (*2)

Dolby TrueHD [DOLBY HD] (*1)

Maximum number of channels: 7.1

Connection with the receiver: HDMI (*4)

DTS [DTS]

Maximum number of channels: 5.1

Connection with the receiver: COAXIAL/OPTICAL, HDMI (*2)

DTS-ES Discrete [DTS-ES Dsc]

Maximum number of channels: 6.1

Connection with the receiver: COAXIAL/OPTICAL, HDMI (*2)

DTS-ES Matrix [DTS-ES Mtx]

Maximum number of channels: 6.1

Connection with the receiver: COAXIAL/OPTICAL, HDMI (*2)

DTS 96/24 [DTS 96/24]

Maximum number of channels: 5.1

Connection with the receiver: COAXIAL/OPTICAL, HDMI (*2)

DTS-HD High Resolution Audio [DTS-HD HR] (*1)

Maximum number of channels: 7.1

Connection with the receiver: HDMI (*2)

DTS-HD Master Audio [DTS-HD MA] (*1)

Maximum number of channels: 7.1

Connection with the receiver: HDMI (*4)

DSD [DSD] (*1) (*3)

Maximum number of channels: 5.1

Connection with the receiver: HDMI

Multi Channel Linear PCM (*1) [PCM]

Maximum number of channels: 7.1

Connection with the receiver: HDMI (*2)

*1 Audio signals are output in another format if the playback device does not correspond to the actual format. For details, refer to the operating instructions of the playback device.

*2 These formats are compatible with MHL when you connect an MHL-compatible source device to the HDMI/MHL (VIDEO 2 IN) (for STR-DN1060 only) or HDMI IN SAT/CATV (MHL) jack.

*3 This format is not output to wireless headphones.

*4 These formats are compatible with MHL when you connect an MHL-compatible source device to the HDMI IN SAT/CATV (MHL) jack.

Notes on connecting cables

- Be sure to disconnect the AC power cord (mains lead) before connecting cables.
- It is not necessary to connect all of the cables. Connect cables according to the availability of jacks on the connected device.
- Use a High Speed HDMI cable. 1080p, Deep Color (Deep Colour), 4K or 3D images may not be displayed properly if you use a Standard HDMI cable.
- We do not recommend using an HDMI-DVI conversion cable. If you connect an HDMI-DVI conversion cable to a DVI-D device, the sound and/or image may be lost. Connect separate audio cables or digital connecting cables, then reassign the input jacks if the sound is not output correctly.
- When connecting optical digital cables, insert the plugs straight until they click into place.
- Do not bend or tie optical digital cables.

Hint

- All of the digital audio jacks are compatible with 32 kHz, 44.1 kHz, 48 kHz and 96 kHz sampling frequencies.

If you want to connect several digital devices, but cannot find an unused input

In this case, reassign the input jacks.

About HDMI connections

High-Definition Multimedia Interface (HDMI) is an interface that transmits video and audio signals in digital format. Connecting Sony “BRAVIA” Sync-compatible devices using HDMI cables simplifies operations.

HDMI features

- Digital audio signals transmitted by HDMI can be output from the speakers connected to the receiver. This signal supports Dolby Digital, DTS, DSD, and Linear PCM.
- The receiver can receive Multi Channel Linear PCM (up to 8 channels) with a sampling frequency of 192 kHz or less via an HDMI connection.
- This receiver supports High Bitrate Audio (DTS-HD Master Audio, Dolby TrueHD), Deep

Color (Deep Colour), “x.v.Color (x.v.Colour),” and 4K or 3D transmission.

- To enjoy 3D images, connect a 3D-compatible TV and video device (Blu-ray Disc player, Blu-ray Disc recorder, PlayStation 4, etc.) to the receiver using High Speed HDMI cables, put on 3D glasses, and then play 3D-compatible content.
- To enjoy 4K (HDMI IN SA-CD/CD, BD/DVD, SAT/CATV (MHL), GAME, VIDEO 1 (*), VIDEO (**)) images, connect a 4K-compatible TV or video device (Blu-ray Disc player, etc.) to the receiver using High Speed HDMI cables, and then play 4K-compatible content.
- The HDMI jacks designated as being “HDCP 2.2” support High-bandwidth Digital Content Protection System Revision 2.2 (HDCP 2.2). Connect these HDMI jacks to jacks that support HDCP 2.2 on the TV and device. Refer to the operating instructions of the connected device for details.

* For STR-DN1060 only.

** For STR-DN860 only.

Note

- Depending on the TV or video device, 4K or 3D images may not be displayed. Check the HDMI video formats supported by the receiver.
- Refer to the operating instructions of each connected device for details.

[37] Preparation | 4. Connecting audio-visual devices and the antennas (aerials)

About MHL (Mobile High-Definition Link) connections

MHL (Mobile High-Definition Link) is an HD video and digital audio interface for connecting mobile phones and portable devices to HDTVs and other home entertainment products. MHL supports 4K (Ultra HD) video and digital audio signals and can simultaneously supply power to the mobile device. It also enables the TV remote control and other home entertainment products to control the mobile device and access its contents.

Hint

- MHL-compatible mobile devices are charged when connected to the HDMI/MHL (VIDEO 2 IN) (*), HDMI IN SAT/CATV (MHL) jacks of the receiver while the receiver is turned on.

* For STR-DN1060 only

[38] Preparation | 5. Connecting to the network

Connecting the receiver to the network using a LAN

cable (for wired LAN connections only)

The following illustration is an example configuration of a home network with the receiver and a server.

We recommend that you connect the server to the router with a wired connection.

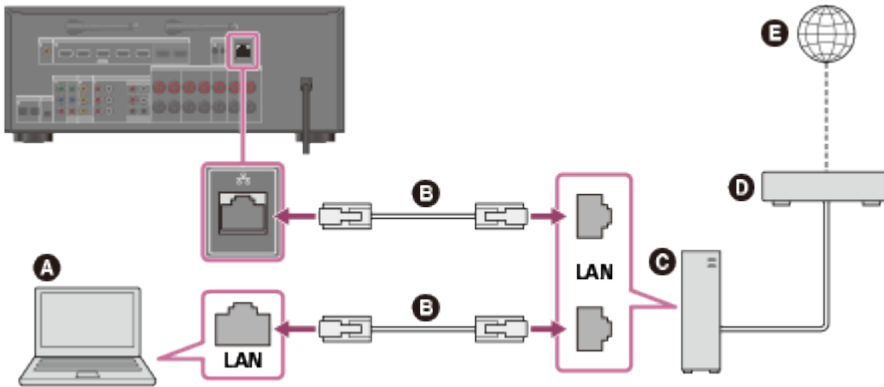

- A** Server (computer, etc.)
- B** LAN cable (not supplied)
- C** Router
- D** Modem
- E** Internet

[39] Preparation | 5. Connecting to the network

Connecting the receiver to the network using the wireless LAN antenna (for wireless LAN connections only)

The following illustration is an example configuration of a home network with the receiver and a server.

We recommend that you connect the server to the router with a wired connection.

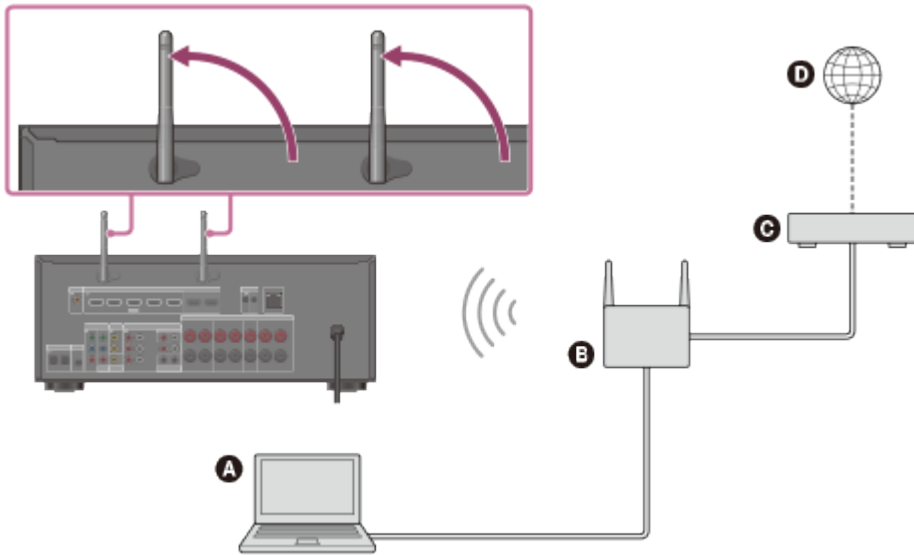

- A** Server (computer, etc.)
- B** Router
- C** Modem
- D** Internet

Note

- Audio playback on a server may occasionally be interrupted if you use a wireless connection.
- When using Screen mirroring, BLUETOOTH TX or BLUETOOTH RX function, stand up both wireless LAN antennas for better performance.

[40] Preparation | 6. Turning on the receiver/preparing the remote control

Inserting batteries into the remote control

Insert two R03 (size AAA) batteries (supplied) into the remote control. Make sure that the + and – ends are in the correct position when installing batteries.

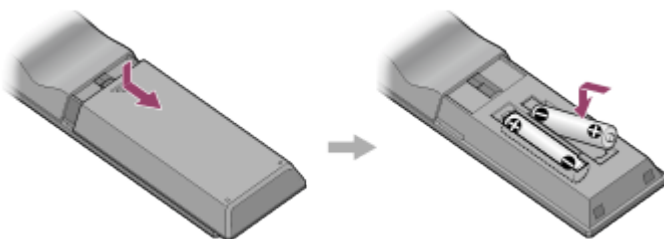

Note

- Do not leave the remote control in an extremely hot or humid place.
- Do not use a new battery with an old one.
- Do not mix manganese batteries with other kinds of batteries.

- Do not expose the remote control sensor to direct sunlight or lights. Doing so may cause a malfunction.
- If you do not intend to use the remote control for an extended period of time, remove the batteries to avoid possible damage from battery leakage and corrosion.
- When the receiver no longer responds to the remote control, replace both of the batteries with new ones.

[41] Preparation | 6. Turning on the receiver/preparing the remote control

Turning on the receiver

When you have made all connections with the other devices, connect the AC power cord (mains lead), then turn on the receiver.

1. Connect the AC power cord (mains lead) to a wall outlet.

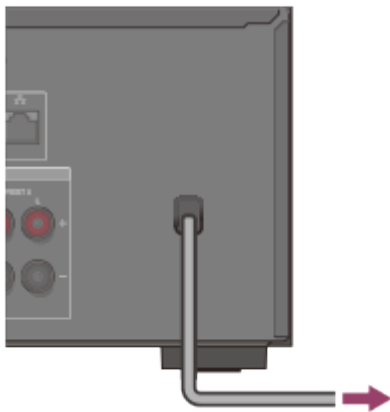

2. Press $I/\text{⏻}$ (on/standby) to turn on the receiver.



You can also turn on the receiver using $I/\text{⏻}$ (on/standby) on the remote control. To turn off the receiver, press $I/\text{⏻}$ (on/standby) again.

Note

- After you turn off the receiver, [STANDBY] flashes on the display panel. Do not disconnect the AC power cord (mains lead) while [STANDBY] is flashing. This may cause a malfunction.

[42] Preparation | 7. Setting up the receiver using Easy Setup

Setting up the receiver using Easy Setup

When you turn on the receiver for the first time or after the receiver is initialized, the Easy Setup screen appears on the TV screen. You can set up the following settings for the receiver by following the instructions on the Easy Setup screen.

- **Speaker Settings**

Check your speaker system and perform automatic calibration according to the configuration and arrangement of your speaker system.

- **Internet Settings**

Configure settings to connect the receiver to the network.

Note

- Switch the input of the TV to the input to which the receiver is connected to use this function.
- Auto Calibration is not available when [Bluetooth Mode] is set to [Transmitter].

If the Easy Setup screen does not appear or you want to display the Easy Setup screen manually, you can display it by selecting [Setup] - [Easy Setup] from the home menu.

[43] Preparation | Tips for automatic calibration (Auto Calibration)

1. About Auto Calibration

Auto Calibration allows you to perform automatic calibration as follows.

- Check the connection between each speaker and the receiver.
- Adjust the speaker level.
- Measure the distance of each speaker from your seating position. (*)
- Measure the speaker size. (*)
- Measure the frequency characteristics (EQ). (*)
- Measure the frequency characteristics (Phase). (*)(**)

* The measurement result is not utilized when [Analog Direct] is selected.

** The measurement result may be not utilized, depending on the audio formats.

Note

- The D.C.A.C. is designed to achieve proper sound balance for your room. However, you can adjust the speaker levels manually according to your preference using [Test Tone].

[44] Preparation | Tips for automatic calibration (Auto Calibration)

2. Before you perform Auto Calibration

Before you perform Auto Calibration, check the following items:

- Set up and connect the speakers.
- Do not connect any microphones other than the supplied optimizer microphone to the AUTO CAL MIC jack.
- If using a bi-amplifier connection or speakers with a front B connection, set the assignment for the SPEAKERS SURROUND BACK/BI-AMP/FRONT HIGH/FRONT B terminals properly.
- Set the speaker output to a setting other than [SPK OFF].
- Disconnect the headphones.
- Remove any obstructions between the optimizer microphone and the speakers.
- For accurate measurement, make sure the environment is quiet and free from noise.

Note

- Auto Calibration is not available when [Bluetooth Mode] is set to [Transmitter].
- The speakers emit very loud sound during the calibration and the volume cannot be adjusted. Be considerate of your neighbors and any children who are present.
- If the muting function has been activated before you perform Auto Calibration, the muting function will shut off automatically.
- It may not be possible to take the correct measurements or to perform Auto Calibration at all if special speakers such as dipole speakers are used.

[45] Preparation | Tips for automatic calibration (Auto Calibration)

3. Connecting the optimizer microphone

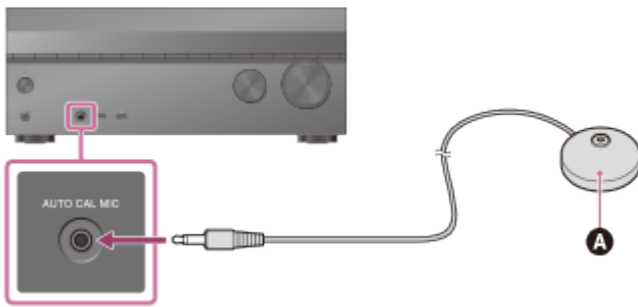

A Optimizer microphone (supplied)

1. Connect the supplied optimizer microphone to the AUTO CAL MIC jack.
2. Set up the optimizer microphone.
Place the optimizer microphone where you will sit and set it at the same height as your ears.

[46] Preparation | Tips for automatic calibration (Auto Calibration)

4. Selecting the front speakers

You can select the front speakers you want to operate.

Be sure to use the buttons on the receiver to perform this operation.

1. Press SPEAKERS on the receiver repeatedly to select the front speaker system you want to operate.



The indicators on the display panel shows which set of terminals are selected.

- **SP A :**
Speakers connected to the SPEAKERS FRONT A terminals.
- **SP B (*):**
Speakers connected to the SPEAKERS SURROUND BACK/BI-AMP/FRONT

HIGH/FRONT B terminals.

- **SP A+B (*)**:

Speakers connected to both the SPEAKERS FRONT A and SPEAKERS SURROUND BACK/BI-AMP/FRONT HIGH/FRONT B terminals (parallel connection).

- **(None)**:

[SPK OFF] appears on the display panel. No audio signals are output from any speaker terminals.

* To select [SP B] or [SP A+B], set the assignment for the SPEAKERS SURROUND BACK/BI-AMP/FRONT HIGH/FRONT B terminals to [Front B] by using [Sur Back SP Assign] in the Speaker Settings menu.

Note

- This setting is not available when headphones are connected.
- When you press SPEAKERS on the receiver, the [Bluetooth Mode] changes to [Receiver] automatically.

[47] Preparation | Tips for automatic calibration (Auto Calibration)

5. Performing Auto Calibration

You can perform automatic calibration from where you are sitting.

1. Select [Setup] - [Speaker Settings] from the home menu.
2. Select [Auto Calibration].
3. Follow the instructions on the TV screen, then press \leftarrow to select [Start].
The measurement starts in 5 seconds.
The measurement process will take approximately 30 seconds with a test tone.
When the measurement ends, a beep sounds and the screen switches.
4. Select the item you want.
 - **Save**: Saves the measurement results and exits the setting process.
 - **Retry**: Performs the Auto Calibration again.
 - **Discard**: Exits the setting process without saving the measurement results.

For details on the measurement results, see "[6. Checking Auto Calibration results.](#)"

5. Save the measurement results.
Select [Save] in step 4.

Note

- If an error code or warning message appears on the screen in step 3, see “[List of messages after Auto Calibration measurements.](#)”
- This setting is not available when headphones are connected.

Hint

- The Auto Calibration function will be canceled if you perform the following during the measurement process:
 - Press I/O .
 - Press the input buttons on the remote control or turn INPUT SELECTOR on the receiver.
 - Press M .
 - Press SPEAKERS on the receiver.
 - Change the volume level.
 - Connect headphones.

[48] Preparation | Tips for automatic calibration (Auto Calibration)

6. Checking Auto Calibration results

To check error codes or warning messages received in [Auto Calibration], proceed with the following steps:

If an error code appears

Check the error and perform Auto Calibration again.

1. Select [Retry].
2. Follow the instructions on the TV screen and then press ↵ to select [Start].
The measurement starts in five seconds.
The measurement process will take approximately 30 seconds with a test tone.
When the measurement ends, a beep sounds and the screen switches.
3. Select the item you want.
 - **Save:** Saves the measurement results and exits the setting process.
 - **Retry:** Performs the Auto Calibration again.
 - **Discard:** Exits the setting process without saving the measurement results.
4. Save the measurement results.
Select [Save] in step 3.

If a warning message appears

Check the warning message and select [OK]. For details on the warning messages, see “[List](#)

of messages after Auto Calibration measurements.”

Hint

- The measurement results may vary depending on the position of the subwoofer. However, continuing to use the receiver with that value does not cause problems.

[49] Enjoying Video and Sound | Playing AV devices

Enjoying Video and Sound

This topic explains the operations you can use to enjoy movies and music with this receiver. For example, you can use multiple devices with this receiver as shown below.

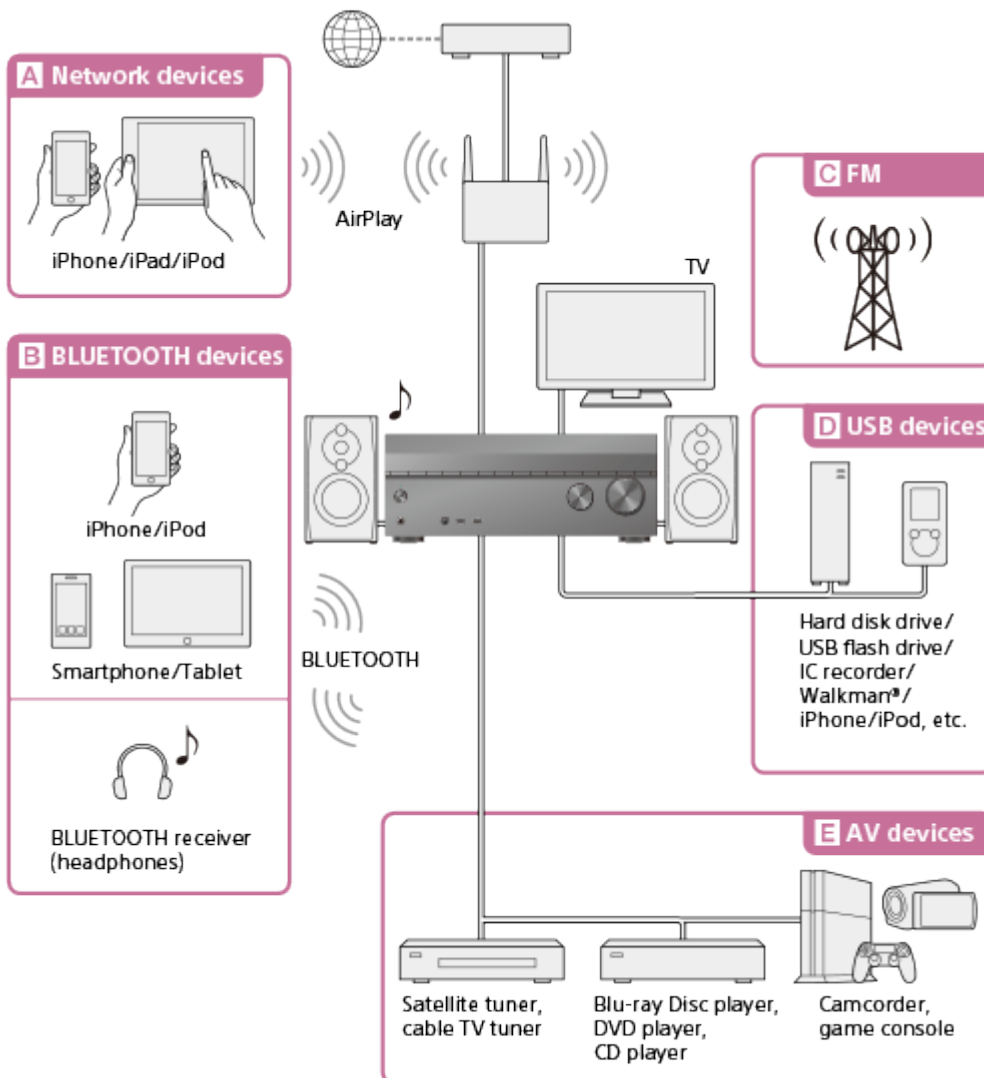

A Network devices

Enjoying audio content from an iPhone/iPad/iPod or other smartphone

You can send content such as audio from an iPhone/iPad/iPod or other smartphone to the receiver via the network.

Enjoying audio content from iTunes or an iPhone/iPad/iPod via the network (AirPlay)

B BLUETOOTH devices

Enjoying audio content from an iPhone/iPod or other smartphone

You can transmit audio from an iPhone/iPod or other smartphone to the receiver via BLUETOOTH.

Enjoying audio content using the BLUETOOTH function (Pairing operation)

Listening with BLUETOOTH headphones

The BLUETOOTH TX function lets you enjoy listening to audio using BLUETOOTH headphones. This function does not need cables, so you can choose where you want to listen to music without worrying about cables.

Listening with BLUETOOTH headphones (Pairing operation)

C FM

Listening to FM radio

You can listen to FM broadcasts in high-quality sound through the built-in tuner. Preset function enables you to store up to 30 of your favorite FM stations as presets.

Listening to FM radio

D USB devices

Enjoying content from a USB device

You can enjoy music from a USB device such as an external hard disk, USB flash drive or Walkman® by connecting it to the ψ (USB) port on the front of the receiver and listening through speakers or headphones connected to the receiver. The receiver is compatible with High Resolution Audio, which means you can enjoy high resolution audio from compatible devices without the loss of sound quality.

Enjoying content stored on a USB device

E AV devices

Enjoying movies or audio from an AV device such as a Blu-ray Disc player, CD player, satellite tuner or game console

You can connect AV devices to the receiver to enjoy a wide range of content such as movies and audio.

As the receiver is equipped with an HDCP 2.2-compatible HDMI jack, you can also enjoy 4K content via satellite broadcasts, etc.

Enjoying video/sound from the connected device

You can display the menu of the receiver on the TV screen (*).

* For STR-DN1060, this is only possible when the TV is connected to the HDMI OUT A (TV) jack.

1. Switch the input of the TV to the input to which the receiver is connected.
2. Press HOME to display the home menu on the TV screen.

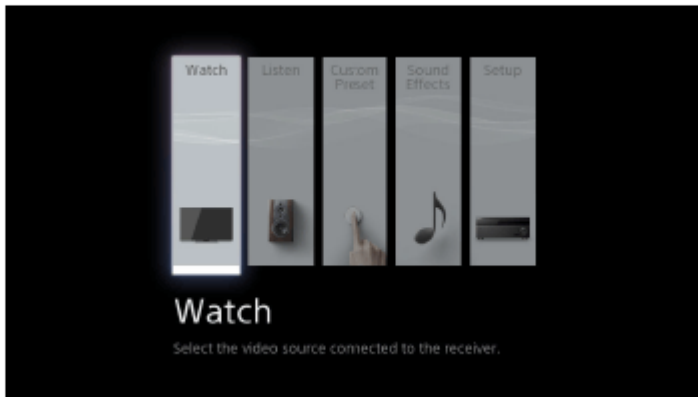

3. Press $\uparrow/\downarrow/\leftarrow/\rightarrow$ repeatedly to select the menu you want, then press ENTER to enter the menu.

Home menu items

Watch: Select to display video from the connected device.

Listen: Select to listen to sound from the connected device.

Custom Preset: Select to save various settings for the receiver and recall those settings.

Sound Effects: Select to enjoy sound effects.

Setup: Select to adjust the various settings for the receiver.

Hint

- When [OPTIONS] appears in the lower left portion of the TV screen, you can display the function list by pressing OPTIONS and selecting a related function.
- To return to the previous screen, press BACK.
- To exit the menu, press HOME to display the home menu, then press HOME again.

[51] Enjoying Video and Sound | Playing AV devices

Enjoying video/sound from the connected device

1. Switch the input of the TV to the input to which the receiver is connected.
2. Press HOME.
The home menu is displayed on the TV screen.

Depending on the TV, the home menu may take some time to appear on the TV screen.

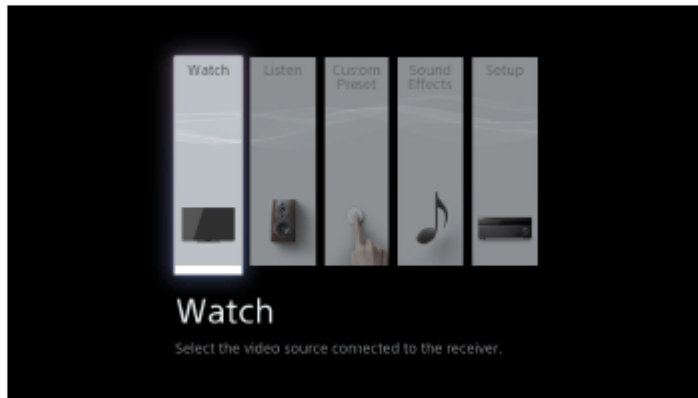

3. Select [Watch] or [Listen] from the home menu.
The menu item list appears on the TV screen.
4. Select the device you want.
5. Turn on the device and start playback.
6. Press \triangle +/- to adjust the volume.
You can also use MASTER VOLUME on the receiver.
7. Press A.F.D./2CH, MOVIE or MUSIC to enjoy the surround sound.
You can also use A.F.D./2CH, MOVIE or MUSIC on the receiver.

Note

- Before you turn off the receiver, be sure to turn down the volume level to avoid damaging your speakers.

Hint

- You can turn INPUT SELECTOR on the receiver or press the input buttons on the remote control to select the device you want.
- You can adjust the volume differently using the MASTER VOLUME knob on the receiver or the \triangle +/- buttons on the remote control.

To turn the volume up or down quickly

- Turn the knob quickly.
- Press and hold one of the buttons.

To make fine adjustments

- Turn the knob slowly.
- Press one of the buttons and release it immediately.

Enjoying sound of an ARC (Audio Return Channel) compatible TV

If your TV supports the Audio Return Channel (ARC) function, set the receiver by the following procedure to output the sound of the TV from the speakers connected to the receiver.

1. Select [Setup] - [HDMI Settings] from the home menu.
2. Select [Control for HDMI].
3. Select [On].

If you connect to a TV that is not compatible with the Audio Return Channel (ARC) function or you want to select an audio signal using a cable other than an HDMI cable (e.g. via an optical digital cable or an audio cable)

Switch the audio input mode.

Note

- Be sure to turn off the volume of the TV or activate the muting function of the TV.
- If your TV does not support the System Audio Control function, set [Audio Out] to [TV + AMP] in the HDMI Settings menu to output the sound of the TV from the TV speaker and the speakers connected to the receiver.

[53] Enjoying Video and Sound | Playing AV devices

Watching HDCP 2.2 Copyright-protected Content

To watch HDCP 2.2 copyright-protected content such as 4K content, connect the receiver and TV via an HDCP 2.2-compatible HDMI jack. You can only view copyright-protected 4K content through the HDCP 2.2-compatible HDMI jack connection. For details on whether the TV and 4K devices are equipped with an HDCP 2.2-compatible HDMI jack, refer to the operating instructions of the TV and 4K devices.

[54] Enjoying Video and Sound | Playing content from an iPhone/iPad/iPod

Enjoying audio content stored on an iPhone/iPod via the

USB port

You can enjoy music from an iPhone/iPod by connecting it to the ψ (USB) port on the receiver.

1. Select [Watch] or [Listen] - [USB] from the home menu.
When the iPhone/iPod is connected, a list of its contents appears on the TV screen.
You can operate the iPhone/iPod using the remote control of the receiver.
2. Select the content you want from the content list.
The selected content starts playing and the information of content appears on the TV screen.

Operating the iPhone/iPod using the remote control

Press USB before you use the following buttons:

- $\blacktriangleright \parallel$: Starts or pauses playback.
- \blacksquare : Stops playback.
- \lll / \ggg : Moves to the start of the previous/current or next track. Press and hold to perform fast forward or fast reverse the current track.

Note

- When connecting the receiver to the network via a wired LAN connection, the USB function temporarily may not work due to the power status of the router or the network connection status, etc. Please wait as the function will recover after a short period of time.

[55] Enjoying Video and Sound | Playing content from an iPhone/iPad/iPod

Enjoying audio content from iTunes or an iPhone/iPad/iPod via the network (AirPlay)

You can play audio content on an iPhone, iPad, iPod or in an iTunes Library on your PC with this receiver via a wireless network.

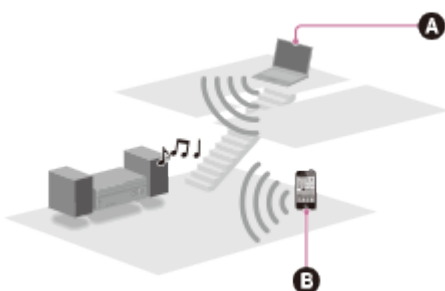







- A PC
- B iPhone/iPad/iPod

1. Tap/click  icon on the iPhone/iPad/iPod screen or iTunes window.
2. Select [STR-DN1060 XXXXXX] (*) or [STR-DN860 XXXXXX] (*) on the AirPlay menu of iTunes or your iPhone/iPad/iPod.
3. Start playing back audio content on an iPhone/iPad/iPod or in iTunes.

* XXXXXX is the identification number for each unit.

Controlling AirPlay playback

You can use the  +/-,  , , ,  buttons on the remote control when the receiver is selected as the device for output.

Note

- Update the iPhone/iPad/iPod or iTunes to the latest version before using with the receiver.
- Refer to the operating instructions of your device for details on operating the iPhone/iPad/iPod, iTunes or AirPlay.

Hint

- If the playback does not start, perform the process again from step 1.
- Very loud sound may output from the receiver if you set the volume loud on an iPhone/iPad/iPod or iTunes.
- It may not be possible to link the volume level of an iPhone/iPad/iPod or iTunes with the volume level of this receiver.

[56] Enjoying Video and Sound | Playing content from an iPhone/iPad/iPod

Enjoying audio content using the BLUETOOTH function (Pairing operation)

Pairing is an operation where BLUETOOTH devices are registered to each other before connection. Once a pairing operation is performed, it does not need to be performed again. Be sure to set the [Bluetooth Mode] to [Receiver] before pairing a device with this receiver.

1. Place the BLUETOOTH device within 1 meter (3.3 feet) of the receiver.
2. Press and hold CONNECTION PAIRING BLUETOOTH on the receiver to select the

BLUETOOTH function.

[PAIRING] flashes on the display panel. Perform step 3 within five minutes, otherwise pairing will be canceled. If pairing is canceled, repeat this step.

3. Perform pairing on the BLUETOOTH device to detect this receiver.
For details, refer to the operating instructions of your BLUETOOTH device.
A list of detected devices may appear on the BLUETOOTH device display depending on the type of BLUETOOTH device. This receiver is displayed as [STR-DN1060] or [STR-DN860].
4. Select [STR-DN1060] or [STR-DN860] on the BLUETOOTH device display.
If [STR-DN1060] or [STR-DN860] is not displayed, repeat this process from step 1.
5. When the BLUETOOTH connection is established, the device name appears and [BT] lights in the display panel.
6. Start playback on the BLUETOOTH device.
7. Adjust the volume.
Adjust the volume of the BLUETOOTH device first. If the volume level is still too low, adjust the volume level of the receiver.

Canceling pairing operation

Switch the input.

Note

- When establishing a connection with this receiver in step 4, select the audio profile (A2DP or AVRCP) on the BLUETOOTH device. If the BLUETOOTH device does not support the AVRCP profile, you cannot perform playback or other operations on the receiver.
- If a passkey is required on the display of the BLUETOOTH device in step 5, enter [0000]. The passkey may be called “Passcode,” “PIN code,” “PIN number” or “Password.”
- You can pair up to 9 BLUETOOTH devices. If a 10th BLUETOOTH device is paired, the least recently connected device will be replaced by the new one.
- CONNECTION PAIRING BLUETOOTH on the receiver does not work when the [Bluetooth Mode] is set to [Off].

Hint

- You can change the name of the receiver that appears on your device in [Device Name] in the System Settings menu.
- On some types of BLUETOOTH devices, you can adjust the volume using the controls of the BLUETOOTH device.

Compatible iPhone/iPad/iPod models

You can use the following iPhone/iPad/iPod models on this receiver. Update your iPhone/iPad/iPod with the latest software before using it.

USB works with

- **iPhone:**
iPhone 6 Plus/iPhone 6/iPhone 5s/iPhone 5c/iPhone 5/iPhone 4s/iPhone 4/iPhone 3GS/iPhone 3G
- **iPod touch:**
iPod touch (2nd through 5th generation)
- **iPod:**
iPod classic
- **iPod nano:**
iPod nano (3rd through 7th generation)

BLUETOOTH technology works with

- **iPhone:**
iPhone 6 Plus/iPhone 6/iPhone 5s/iPhone 5c/iPhone 5/iPhone 4s/iPhone 4/iPhone 3GS
- **iPod touch:**
iPod touch (4th and 5th generation)

AirPlay works with

- **iPhone:**
iPhone 6 Plus/iPhone 6/iPhone 5s/iPhone 5c/iPhone 5/iPhone 4s/iPhone 4/iPhone 3GS
- **iPad:**
iPad Air 2/iPad mini 3/iPad Air/iPad mini 2/iPad mini/iPad (4th and 3rd generation)/iPad 2
- **iPod touch:**
iPod touch (3rd through 5th generation)

AirPlay works with iPhone, iPad, and iPod touch with iOS 4.3.3 or later, Mac with OS X Mountain Lion or later, and PC with iTunes 10.2.2 or later.

[58] Enjoying Video and Sound | Playing content from an iPhone/iPad/iPod

Notes on iPhone/iPad/iPod

- Sony cannot accept responsibility in the event that data recorded to an iPhone/iPad/iPod is lost or damaged when using an iPhone/iPad/iPod connected to this receiver.
- iPhone/iPod is charged when connected to the receiver while the receiver is turned on.

- You cannot transfer songs onto the iPhone/iPad/iPod from the receiver.
- Do not remove the iPhone/iPad/iPod during operation. To avoid data corruption and damage to the iPhone/iPad/iPod, turn the receiver off when connecting or removing the iPhone/iPad/iPod.

[59] Enjoying Video and Sound | Playing content from a USB device



Enjoying content stored on a USB device

You can enjoy music/photos from a USB device by connecting it to the  (USB) port on the receiver.

1. Select [Watch] or [Listen] - [USB] from the home menu.
When the USB device is connected, [USB] appears on the TV screen. You can operate the USB device using the remote control of the receiver.
2. Select [Music] or [Photo].
3. Select the content you want from the content list.
The selected content starts playing and the information of content appears on the TV screen.

Operating the USB device using the remote control

Press USB before you use the following buttons:

- : Starts or pauses playback.
- : Stops playback.
- : Moves to the start of the previous/current or next track. Press and hold to perform fast forward or fast reverse the current track.

Note

- To listen to music files stored on your Walkman, you need to drag and drop the files in formats supported by the receiver (such as MP3) from your computer to the Walkman. However, music files transferred to the Walkman using Media Go can be played back on the receiver because the files are stored in the [Music] folder.
- Audio content with DRM (Digital Rights Management) copyright protection cannot be played on this receiver.

[60] Enjoying Video and Sound | Playing content from a USB device

USB specifications and Compatible USB devices

File formats playable via USB connection

Supported music formats (*1)

MP3 (MPEG 1 Audio Layer-3) (*2):

.mp3

AAC/HE-AAC:

.m4a, .aac, .mp4 (*3), .3gp (*3)

WMA9 Standard:

.wma

WMA 10 Pro (*4):

.wma

LPCM (*2):

.wav

FLAC:

.flac, .fla

Dolby Digital (*2):

.ac3

DSF:

.dsf

DSDIFF (*5):

.dff

AIFF:

.aiff, .aif

ALAC:

.m4a

Monkey's Audio:

.ape

Vorbis:

.ogg

Supported photo formats

JPEG:

.jpeg, .jpg, .jpe

PNG:

.png (*6)

GIF:

.gif (*6)

*1 Compatibility with all encoding/writing software, recording devices and recording media cannot be guaranteed.

*2 The receiver can play “.mka” files.

*3 The receiver can only play “.mp4” and “.3gp” audio file formats.

*4 The receiver does not play coded files such as Lossless.

*5 The receiver does not play DST encoded files.

*6 The receiver does not play animated PNG or animated GIF files.

Note

- Some files may not play depending on the file format, the file encoding or the recording condition.
- Some files that have been edited on a PC may not play.
- Fast forward or fast reverse functions may not be available for some files.
- The receiver does not play 3D photo files.
- The receiver does not play coded files such as DRM.
- The receiver can recognize the following files or folders in USB devices:
 - up to folders in the 9th layer (including the root folder)
 - up to 500 files/folders in a single layer
- Some USB devices may not work with this receiver.
- The receiver can recognize Mass Storage Class (MSC) devices (such as flash memory or an HDD), Still Image Capture Devices (SICDs), and 101-key keyboards.

Compatible USB device

Mass Storage Class, High-speed type

Maximum current

500 mA

Verified Sony USB devices

You can use the following Sony USB devices on this receiver:

Walkman:

NWZ-W263/W274S

NWZ-E375/E385/E465/E575/E585

NWZ-S765/S775

NWZ-A867

NWZ-Z1070

NWZ-B173F/B183F
NWZ-F806/F887
NWZ-ZX1
NWZ-A15/A17
NWZ-WS613/WS615
NWZ-M504

MICROVAULT:

USM4GL/USM8GL/USM32GL
USM4GM
USM8GN/USM32GN
USM8GQ/USM32GQ/USM64GQ
USM32GLX/USM64GLX
USM8GR/USM16GR/USM32GR
USM64GP
USM8GT
USM16GU
USM4GV
USM8GQX/USM128GQX
USM32W
USM16SA1
USM32X

Digital Voice Recorder:

ICD-UX502/UX523F/UX534F/UX544F
ICD-TX50/TX650
ICD-FX8
ICD-PX232/PX440
ICD-BX332
ICD-SX733
ICZ-R51/R100/R250TV
PCM-D100

Note

- The receiver is unable to read data other than that saved in the first partition of a hard disk drive.
- Operation of models not listed here is not guaranteed.
- Operation may not always be guaranteed even when using these USB devices.
- Some of these USB devices may not be available for purchase in certain areas.
- When formatting the above models, be sure to format using the model itself or the dedicated formatting software for that model.
- When connecting a USB device to the receiver, be sure to connect after the display

Creating Library or Creating Database on the USB device has disappeared.

[61] Enjoying Video and Sound | Playing content from a USB device

Notes on USB devices

- Do not remove a USB device during operation. To avoid data corruption and damage to the USB device, turn the receiver off when connecting or removing a USB device.
- Do not connect a USB device to the receiver through a USB hub.
- [Photo] and [Music] categories appear on the TV screen when a USB device is connected while the input of the receiver is set to USB.
- The receiver can recognize the following files or folders in USB devices:
 - folders up to the 9th layer (including the root folder)
 - up to 500 files/folders in a single layer

The maximum number of files and folders may vary depending on the file and folder structure. Do not save other types of files or unnecessary folders on a USB device.

- Compatibility with all encoding/writing software, recording devices, and recording media cannot be guaranteed. Incompatible USB devices may produce noise or interrupted audio or may not play at all.
- Some time may be needed to start playback when:
 - the folder structure is complex.
 - the memory capacity is excessive.
- This receiver does not necessarily support all of the functions provided in a connected USB device.
- The playback order for the receiver may differ from the playback order of the connected USB device.
- If a folder that has no files is selected, [No playable file in this category.] appears.
- When playing a very long track, some operations may cause playback delay.

[62] Enjoying Video and Sound | Listening to the radio

Listening to FM radio

You can listen to FM broadcasts through the built-in tuner. Be sure that the FM antenna (aerial) is connected to the receiver before performing this operation.

1. Select [Listen] - [FM TUNER] from the home menu.

The FM screen appears.

FM screen

You can select and operate each item on the screen by pressing $\uparrow/\downarrow/\leftarrow/\rightarrow$ and ↵ .



A: Frequency indication

You can tune to a station automatically by pressing \uparrow/\downarrow repeatedly (Auto Tuning). Press \uparrow to scan from lower to higher frequency stations or press \downarrow to scan from higher to lower frequency stations.

The receiver stops scanning whenever a station is received.

B: Preset station list

You can tune to a station by selecting the preset number from the list.

[63] Enjoying Video and Sound | Listening to the radio

Presetting FM radio stations (Preset Memory)

You can store up to 30 FM stations as your favorite stations.

1. Select [Listen] - [FM TUNER] from the home menu.
2. Tune to the station that you want to preset.
3. Press OPTIONS.
4. Select [Preset Memory] from the options menu.
5. Select a preset number.
The station is stored as the selected preset number.
6. Repeat steps 1 to 5 to store another station.

You can store stations as follows:

- FM band: FM 1 to FM 30

[64] Enjoying Video and Sound | Listening to the radio

Naming preset stations (Name Input)

1. Select [Listen] - [FM TUNER] from the home menu.
2. Select the preset number to which you want to assign a name.
3. Press **OPTIONS**.
The options menu appears.
4. Select [Name Input].
An on-screen keyboard appears on the TV screen.
5. Press \uparrow / \downarrow / \leftarrow / \rightarrow and \cdot to select characters one by one to enter the name.
6. Select [Enter].
The name you entered is registered.

Canceling naming input

Press **BACK**.

Note





- Some letters that can be displayed on the TV screen cannot be displayed on the display panel.





[65] Enjoying Video and Sound | Listening to the radio

Tuning to a station directly (Direct Tuning)

You can enter the frequency of a station directly.

1. Select [Listen] - [FM TUNER] from the home menu.

2. Confirm that the frequency indication on the left of the screen is highlighted and press .
3. Enter the frequency using ///.

 - i. Press / to select a digit.
 - ii. Press / to change the digit.

4. Press .

Note

- If the tuned frequency is invalid or out of range, [---.-- MHz] appears and then the screen returns to the current frequency.
Make sure you have entered the right frequency. If not, repeat steps 3 and 4. If you still cannot tune to a station, the frequency may not be in use in your area.

Hint

- The tuning scale for direct tuning is shown below:
 - **USA and Canadian models**
100 kHz
 - **Other models**
50 kHz

[66] Enjoying Video and Sound | Listening to the radio

Receiving RDS broadcasts (for European and Asia-Pacific models only)

This receiver allows you to use Radio Data System (RDS), which enables FM radio stations (*) to send additional information along with the regular programming signal. This receiver offers convenient RDS features, such as Program Service name display.

* Not all FM stations provide RDS service, nor do they provide the same type of services. If you are not familiar with the RDS services in your area, check with your local radio stations for details.

1. Select [Listen] - [FM TUNER] from the home menu.
 2. Select a station.
When you tune to a station that provides RDS services, the Program Service name appears on the TV screen and the display panel.
-

Note

- RDS may not work properly if the station you tuned to does not transmit the RDS signal or if the signal strength is weak.
- Some letters that can be displayed on the TV screen cannot be displayed on the display panel.

Hint

- You can check the frequency while a Program Service name is displayed by pressing DISPLAY MODE on the receiver repeatedly.

[67] Enjoying Video and Sound | Enjoying sound effects

Selecting a sound field (Sound Field)

You can select from a variety of sound field modes according to speaker connections or input sources.

1. Select [Setup] - [Audio Settings] from the home menu.
2. Select [Sound Field].
3. Select the sound field you want.
For movies, select a sound field labeled with [Movie].
For music, select a sound field labeled with [Music].

Note

- You cannot select sound effects when [Bluetooth Mode] is set to [Transmitter].
- When listening with headphones, only the sound fields for headphones appear.
- The sound fields for movie and music may not work, depending on the input or the speaker pattern you select, or with audio formats.
- The receiver may play signals at a lower sampling frequency than the actual sampling frequency of the input signals, depending on the audio format.
- [PLIIX Movie] or [PLIIX Music] may not appear, depending on the speaker pattern you select.
- Some speakers or the subwoofer may not output sound, depending on the sound field setting.

Hint

- You can also select [Sound Field] in [Sound Effects] from the home menu.
- You can also use A.F.D./2CH, MOVIE or MUSIC on the remote control or the receiver to select a sound field.

Resetting sound fields to the default settings

Be sure to use the buttons on the receiver to perform this operation.

1. Turn off the receiver.
2. Hold down MUSIC and press I/O (on/standby) on the receiver.
[S.F. CLEAR] appears on the display panel and all sound fields are reset to their default setting.

Adjusting the equalizer (Equalizer)

You can use the following parameters to adjust the tonal quality (bass/treble level) of the front, center, surround/surround back and front high speakers.

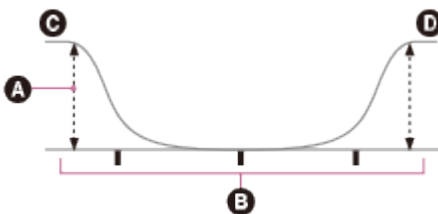

- A** Level (dB)
- B** Frequency (Hz)
- C** Bass
- D** Treble

1. Select [Setup] - [Speaker Settings] from the home menu.
2. Select [Equalizer].
3. Select [Front], [Center], [Surround] or [Front High].
4. Select [Bass] or [Treble].
5. Adjust the gain.

Note

- This function does not work in the following cases:
 - [Analog Direct] is being used.
 - [Pure Direct] is set to [On].
 - [Bluetooth Mode] is set to [Transmitter].
- Frequencies for [Bass] and [Treble] are fixed.
- Depending on the audio format, the receiver may play signals at a lower sampling frequency than the original sampling frequency of the input signals.
- Only [Bass] gain and [Treble] gain are available for [Front] when headphones are connected.

Hint

- You can also select [Equalizer] in [Sound Effects] from the home menu.

[70] Enjoying Video and Sound | Enjoying sound effects

Enjoying clear and dynamic sound at a low volume (Sound Optimizer)

You can enjoy clear and dynamic sound at low volume levels using the Sound Optimizer. After the Auto Calibration is performed, the sound level is optimized to suit your environment.

1. Select [Setup] - [Audio Settings] from the home menu.
2. Select [Sound Optimizer].
3. Select the setting you want.
 - **Normal:** Adjusts for the reference level of a movie.
 - **Low:** Adjusts for a CD or other software whose average sound pressure level is processed highly.
 - **Off**

Note

- This function does not work in the following cases:
 - [Analog Direct] is being used.
 - [Pure Direct] is set to [On].
 - Headphones are connected.
 - [Bluetooth Mode] is set to [Transmitter].
- The receiver may play signals at a lower sampling frequency than the actual sampling

frequency of the input signals, depending on the audio format.

Hint

- You can also select [Sound Optimizer] in [Sound Effects] from the home menu.

[71] Enjoying Video and Sound | Enjoying sound effects

Enjoying more natural sound with speakers installed in the ceiling (In-Ceiling Speaker Mode)

Set whether or not to use in-ceiling speaker mode with the current input.

In a setup where the front and center speakers are installed in the ceiling, lowering the audio output position to the screen height allows you to enjoy a more natural experience.

1. Select [Setup] - [Audio Settings] from the home menu.
2. Select [In-Ceiling Speaker Mode].
3. Select [On].

Note

- This function does not work in the following cases:
 - A speaker pattern with the front high speakers is selected.
 - Headphones are connected.
 - [Bluetooth Mode] is set to [Transmitter].
 - [Pure Direct] is set to [On].
- This function does not work if you select a sound field other than the following:
 - 2ch Stereo
 - A.F.D.: Auto Format Direct
 - Multi Stereo
- This function may not work depending on the audio format.
- The receiver may play signals at a lower sampling frequency than the actual sampling frequency of the input signals depending on the audio format.

Hint

- You can also select [In-Ceiling Speaker Mode] in [Sound Effects] from the home menu.
 - To obtain the optimal sound for your listening environment, configure the [Ceiling Speaker Height] setting in the Speaker Settings menu, then perform Auto Calibration.
-

Enjoying high-fidelity sound (Pure Direct)

You can enjoy higher-fidelity sound from all inputs using the Pure Direct function. When the Pure Direct function is on, the display panel lights off to suppress noise that affects sound quality.

1. Select [Sound Effects] - [Pure Direct] from the home menu.
2. Select [On].

Canceling Pure Direct

The Pure Direct function will be canceled when you perform the following:

- Select [Off] in step 2.
- Press PURE DIRECT on the receiver.
- Change the sound field.
- Change the scene setting on the TV (Scene Select).
- Change the setting of [Equalizer], [Sound Optimizer], [Advanced Auto Volume], [Dynamic Range Compressor], [In-Ceiling Speaker Mode], [Automatic Phase Matching], [Calibration Type] or [LFE Time Alignment].

Note

- [Equalizer], [Sound Optimizer], [Advanced Auto Volume], [Dynamic Range Compressor], [In-Ceiling Speaker Mode], [Automatic Phase Matching], [Calibration Type] and [LFE Time Alignment] do not work when the Pure Direct function is selected.

Hint

- You can also use the PURE DIRECT button on the receiver to turn the Pure Direct function on or off.
- You can also select [Pure Direct] in [Setup] - [Audio Settings] from the home menu.

Displaying the mobile device display on the TV screen (Screen mirroring)

Screen mirroring is a function that displays the screen of a mobile device on the TV using Miracast technology.

You can connect the receiver directly with a device that supports Screen mirroring (e.g. a smartphone, or a tablet) and display the screen of the device on your large TV screen. No wireless router (or access point) is required to use this feature.

1. Press MIRRORING.

You can also select [Watch] - [Screen mirroring] from the home menu.

2. Follow the on-screen instructions.

Activate the Screen mirroring function from your mobile device.

For details on how to activate the function, refer to the operating instructions supplied with your mobile device.

To connect to an Xperia smartphone using the One-touch mirroring function (NFC)

Press MIRRORING, then touch the  mark on the receiver with an Xperia smartphone that supports One-touch mirroring.

To cancel mirroring

Press BACK, or switch the input.

Note

- When using Screen mirroring, the quality of the picture and sound may deteriorate due to interference from other networks.
- The quality of the picture and sound may also deteriorate due to the usage environment.
- Some network functions may not be available during Screen mirroring.
- Make sure that your device is compatible with Miracast. Connectivity with all Miracast compatible devices is not guaranteed.
- When in BLUETOOTH RX mode, BLUETOOTH connection will be canceled when you start Screen mirroring function.

Hint

- If the quality of the picture and sound is often poor, they may be improved by configuring [Screen mirroring RF Setting] in the Network Settings menu.

[74] Using Network Features | About network features

What you can do with network features

You can enjoy playing back audio content in high-quality audio from a computer or network HDD, or iPhone/iPad/iPod or other smartphone or tablet connected to your home network either wired or wirelessly.

You can also enjoy audio services such as internet radio by connecting internet.
You can also control this receiver from a smartphone by using the compatible apps.

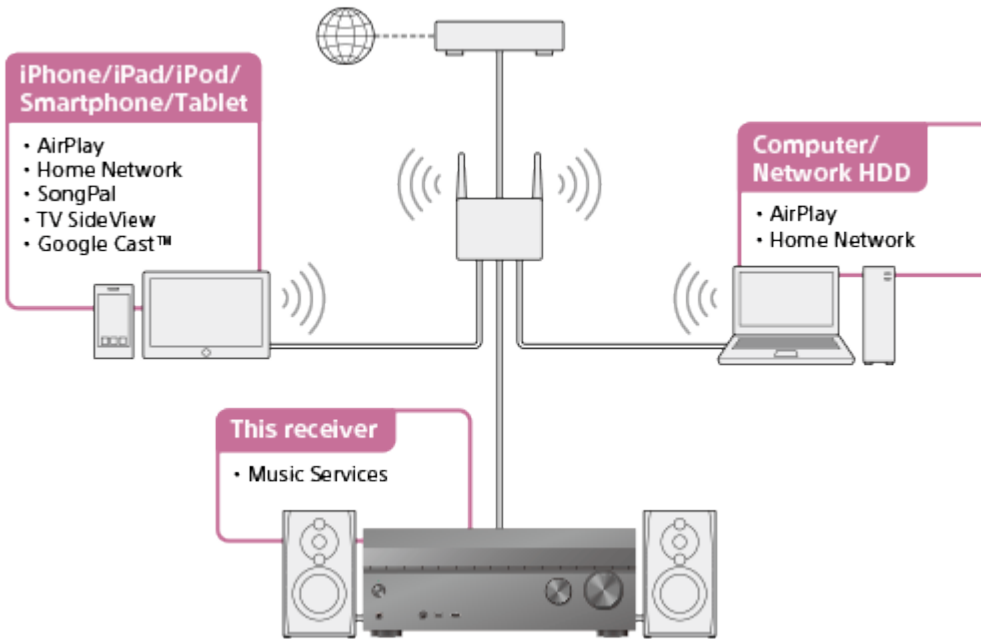

- **AirPlay**

This receiver supports AirPlay. You can enjoy audio content from an iPhone/iPad/iPod or your iTunes Library.

[Enjoying audio content from iTunes or an iPhone/iPad/iPod via the network \(AirPlay\)](#)

- **Home Network**

You can play back audio and photo content stored in various formats on a network location (computer, network HDD etc.) via your home network.

[Enjoying content stored on a server on the home network](#)

- **SongPal**

You can control your receiver wirelessly by installing the “SongPal” App on your smartphone or tablet device.

This feature is recommended when using the contents playback feature, multi-zone features or SongPal Link feature of the receiver.

[Controlling the receiver using a smartphone or tablet device \(SongPal\)](#)

- **TV SideView**

You can control your receiver wirelessly by installing the TV SideView App on your smartphone or tablet device. We highly recommend this App for customers who use a TV manufactured by Sony with the receiver.

[Registering TV SideView device to the receiver](#)

- **Internet music services**

With the receiver connected to the Internet, you can listen to music from a variety of music services.

[75] Using Network Features | Setting up a wired LAN connection (for wired LAN connections only)

Connecting the receiver to the network using a LAN cable (for wired LAN connections only)

The following illustration is an example configuration of a home network with the receiver and a server.

We recommend that you connect the server to the router with a wired connection.

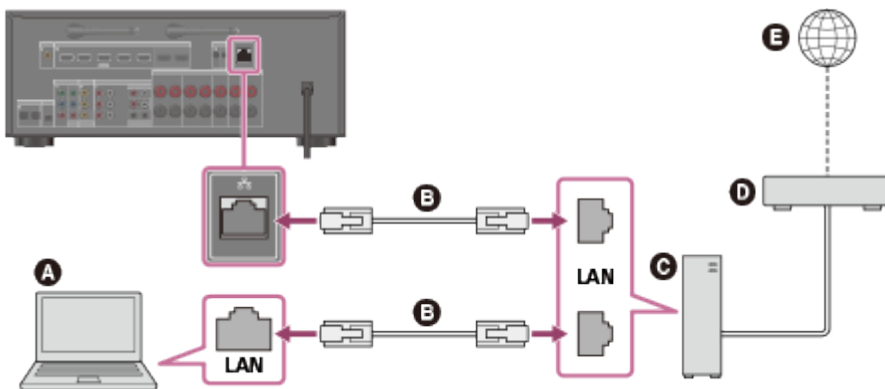

- A** Server (computer, etc.)
- B** LAN cable (not supplied)
- C** Router
- D** Modem
- E** Internet

[76] Using Network Features | Setting up a wired LAN connection (for wired LAN connections only)

Setting up a wired LAN connection

You can set up a wired LAN connection by the following procedure.



1. Select [Setup] - [Network Settings] from the home menu.
2. Select [Internet Settings].
3. Select [Wired Setup].

The screen for selecting the IP address acquisition method appears on the TV screen.

4. Select [Auto].

The system starts connecting to the network.

The confirmation screen appears.

5. Press / to browse information, and then press .

6. Select [Save & Connect].

The system starts connecting to the network. For details, refer to the messages that appear on the TV screen.

If using a fixed IP address

Select [Custom] in step 4 and follow the on-screen instructions.

Hint

- See [Network Connection Status] when checking the network settings.

[77] Using Network Features | Setting up a wireless LAN connection (for wireless LAN connections only)

Connecting the receiver to the network using the wireless LAN antenna (for wireless LAN connections only)

The following illustration is an example configuration of a home network with the receiver and a server.

We recommend that you connect the server to the router with a wired connection.

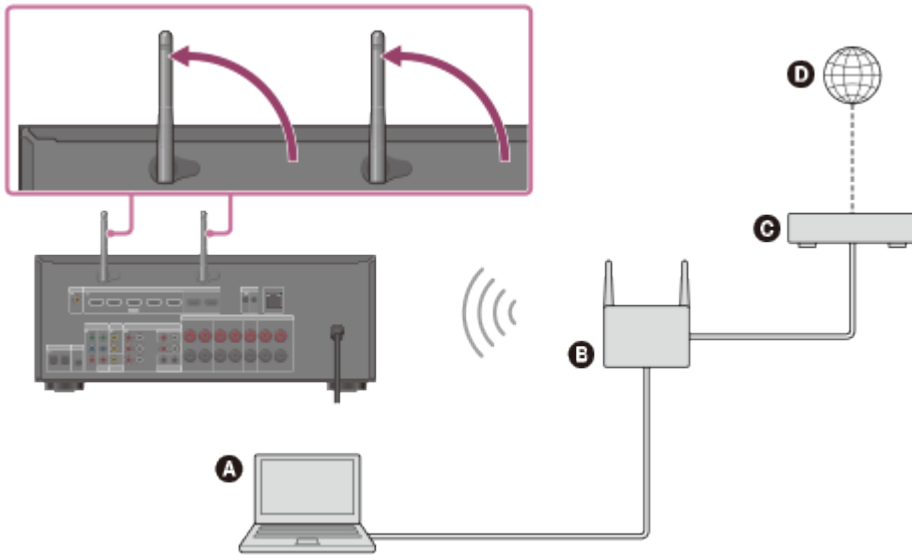

- A Server (computer, etc.)**
- B Router**
- C Modem**
- D Internet**

Note

- Audio playback on a server may occasionally be interrupted if you use a wireless connection.
- When using Screen mirroring, BLUETOOTH TX or BLUETOOTH RX function, stand up both wireless LAN antennas for better performance.

[78] Using Network Features | Setting up a wireless LAN connection (for wireless LAN connections only)

Setting up a wireless LAN connection

Before performing network settings

When your wireless LAN router (access point) is Wi-Fi Protected Setup (WPS)-compatible, you can easily set the network settings with the WPS button.

If not, you will be required to select or enter the following information. Check the following information in advance.

- The network name (SSID) (*) of the wireless LAN router/access point
- The security key (password) (**) for the network

* SSID (Service Set Identifier) is a name that identifies a particular access point.

** This information should be available from a label on your wireless LAN router/access point, from the operating instructions, from the person who set up your wireless network, or from the information provided by your Internet service provider.

1. Select [Setup] - [Network Settings] from the home menu.
2. Select [Internet Settings].
3. Select [Wireless Setup(built-in)].
4. Select [Wi-Fi Protected Setup (WPS)].
5. Select [Start].
6. Press the WPS button on the access point.
The receiver starts connecting to the network.
After the network settings are complete, [📶] lights up on the display panel.

If selecting the network name (SSID) you want

Select the network name (SSID) you want in step 4, enter the security key (or passphrase) using the on-screen keyboard, and then select [Enter] to confirm the security key. The receiver starts connecting to the network. For details, refer to the messages that appear on the TV screen.

When manually inputting a fixed IP address

Select [New connection registration] - [Manual registration] in step 4, then follow the on-screen instructions.

If using a (WPS) PIN code

Select [New connection registration] - [(WPS) PIN Method] in step 4, then follow the on-screen instructions.

Hint

- See [Network Connection Status] when checking the network connection status.

[79] Using Network Features | Enjoying content stored on a server on the home network

Enjoying content stored on a server on the home network

You can enjoy music/photo files, stored on a server on the home network using the receiver. The server may require some settings to be configured to allow the receiver to play music/photo files from the server. For details, refer to the operating instructions or help of the respective devices or applications.

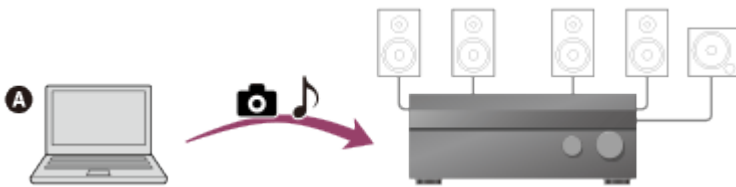

A Server (computer, etc.)

1. Select [Listen] - [Home Network] from the home menu.
A list of available servers appears on the TV screen.
If the last selected item (playlist, album, folder, etc.) appears on the TV screen, press **BACK** to return to the server list.
If there are no available servers, press **OPTIONS** in the [Connection Server Settings] screen in the Network Settings menu and then select [Update Server List].
2. Select the server.
The content list appears on the TV screen.
3. Select the item (playlist, album, folder, etc.) you want.
Repeat this step to narrow down the choices until the item you want appears. The items that are displayed depend on the server you are connected to.
4. Select the file you want to play.
Playback starts.

Note

- Audio content with DRM (Digital Rights Management) copyright protection cannot be played on this receiver.
- There may be some tracks that cannot be played on this receiver.

Hint

- You can also select [Watch] - [Home Network] from the home menu.
- If the server device supports the Wake-on-LAN, the receiver turns the server on automatically in step 2. If the server does not support the Wake-on-LAN, turn on the server in advance. For details on the Wake-on-LAN settings or operations of your server, refer to the operating instructions or help of your server.

[80] Using Network Features | Enjoying content stored on a server on the home network

Deleting a server from the server list

If a server you do not usually use appears in the server list, you can delete it using this function.

1. Select [Setup] - [Network Settings] from the home menu.
2. Select [Connection Server Settings].
3. Select the server which you want to delete and press OPTIONS.
4. Select [Remove] from the options menu.
5. Select [OK] on the confirmation display.
[The device has been removed from the list.] appears on the TV screen, and the selected server is deleted.

Note

- A server will appear in the server list even after being deleted from the list if the receiver finds it on the network (such as when you refresh the server list).

[81] Using Network Features | Enjoying content stored on a server on the home network Setting whether to control this receiver from a controller device on the home network (Renderer Access Control)

You can check a list of products compatible with a controller on the home network and set whether or not each product is accessible via this receiver.

1. Select [Setup] - [Network Settings] from the home menu.
2. Select [Renderer Access Control].
A list of registered controllers appears (up to 40 devices).
3. Select the controller you want to set and press \leftarrow .
4. Select the setting you want.
 - **Allow:** Permits access from the controller.
 - **Block:** Blocks access from the controller.

[82] Using Network Features | Enjoying audio content from iTunes or an iPhone/iPad/iPod via the network (AirPlay)

Compatible iPhone/iPad/iPod models

You can use the following iPhone/iPad/iPod models on this receiver. Update your iPhone/iPad/iPod with the latest software before using it.

USB works with

- **iPhone:**
iPhone 6 Plus/iPhone 6/iPhone 5s/iPhone 5c/iPhone 5/iPhone 4s/iPhone 4/iPhone 3GS/iPhone 3G
- **iPod touch:**
iPod touch (2nd through 5th generation)
- **iPod:**
iPod classic
- **iPod nano:**
iPod nano (3rd through 7th generation)

BLUETOOTH technology works with

- **iPhone:**
iPhone 6 Plus/iPhone 6/iPhone 5s/iPhone 5c/iPhone 5/iPhone 4s/iPhone 4/iPhone 3GS
- **iPod touch:**
iPod touch (4th and 5th generation)

AirPlay works with

- **iPhone:**
iPhone 6 Plus/iPhone 6/iPhone 5s/iPhone 5c/iPhone 5/iPhone 4s/iPhone 4/iPhone 3GS
- **iPad:**
iPad Air 2/iPad mini 3/iPad Air/iPad mini 2/iPad mini/iPad (4th and 3rd generation)/iPad 2
- **iPod touch:**
iPod touch (3rd through 5th generation)

AirPlay works with iPhone, iPad, and iPod touch with iOS 4.3.3 or later, Mac with OS X Mountain Lion or later, and PC with iTunes 10.2.2 or later.

[83] Using Network Features | Enjoying audio content from iTunes or an iPhone/iPad/iPod via the network (AirPlay)

Enjoying audio content from iTunes or an iPhone/iPad/iPod via the network (AirPlay)

You can play audio content on an iPhone, iPad, iPod or in an iTunes Library on your PC with

this receiver via a wireless network.

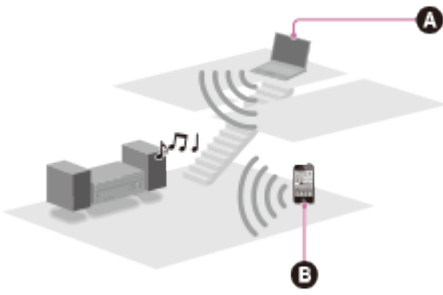





- A PC
- B iPhone/iPad/iPod

1. Tap/click  icon on the iPhone/iPad/iPod screen or iTunes window.
2. Select [STR-DN1060 XXXXXX] (*) or [STR-DN860 XXXXXX] (*) on the AirPlay menu of iTunes or your iPhone/iPad/iPod.
3. Start playing back audio content on an iPhone/iPad/iPod or in iTunes.

* XXXXXX is the identification number for each unit.

Controlling AirPlay playback

You can use the  +/-, , , ,  buttons on the remote control when the receiver is selected as the device for output.

Note

- Update the iPhone/iPad/iPod or iTunes to the latest version before using with the receiver.
- Refer to the operating instructions of your device for details on operating the iPhone/iPad/iPod, iTunes or AirPlay.

Hint

- If the playback does not start, perform the process again from step 1.
- Very loud sound may output from the receiver if you set the volume loud on an iPhone/iPad/iPod or iTunes.
- It may not be possible to link the volume level of an iPhone/iPad/iPod or iTunes with the volume level of this receiver.

You can listen to music services offered on the Internet with this receiver.

To use this function, you need to connect the receiver to the Internet and then follow the guide that is displayed after the following steps.

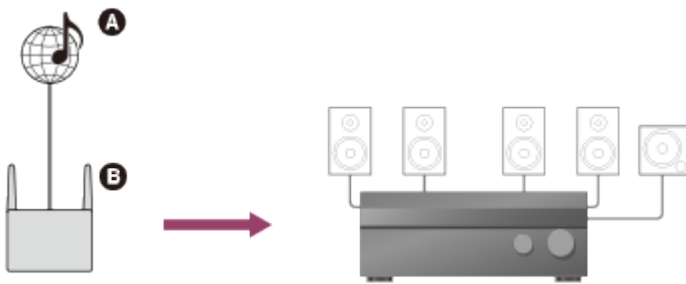

A Internet

B Router

1. Select [Listen] - [Music Services] from the home menu.

The service provider list appears on the TV screen. You can update the service provider list by pressing **OPTIONS**, followed by select [Update List].

2. Select the music service you want.

Note

- Available services may vary depending on your location.

[85] Using Network Features | Using “SongPal” to control the receiver from a smartphone or tablet device

Controlling the receiver using a smartphone or tablet device (SongPal)

“SongPal” is a dedicated app for operating SongPal-compatible audio devices manufactured by Sony using a smartphone or tablet device.

Search for “SongPal” on Google Play or the App Store and download to your smartphone or tablet device.

“SongPal” allows you to:

- change commonly used settings, selecting the input of the system and adjusting the volume.
- enjoy music content stored on a home network server or smartphone on the receiver.
- enjoy music visually with your smartphone display.
- configure Wi-Fi connection settings easily using "SongPal" if your Wi-Fi router does not have a WPS function.

use the SongPal Link function.

1. Download the “SongPal” application to your mobile device.
2. Run “SongPal” and follow the on-screen instructions.
3. Connect your mobile device to the receiver using the NFC function or by manual operation.

After the connection is completed, you can control the receiver using “SongPal.”

Note

- “SongPal” does not support the iPad.
- Before you start to perform the operations above, be sure to set the [Bluetooth Mode] to [Receiver].
- This model is compatible with “SongPal” version 3.0 or later.
- “SongPal” uses the network and BLUETOOTH functions of the receiver.
- Specifications and design of “SongPal” may be changed without prior notice.

[86] Using Network Features | Using “SongPal” to control the receiver from a smartphone or tablet device

Listening to the same music on multiple devices/Listening to different music in a different location (SongPal Link)

You can enjoy music stored on your computer or smartphone or from music services in multiple rooms at the same time.

Refer to the following for details of SongPal Link:

<http://www.sony.net/nasite>

[87] Using Network Features | Using TV SideView to control the receiver from a smartphone or tablet device

Registering TV SideView device to the receiver

You can control the receiver using TV SideView from a mobile device or tablet device.

You need to register your mobile devices in which TV SideView is installed to the receiver

before you use TV SideView for the first time.

Search for TV SideView on Google Play or the App Store and download to your mobile device.

1. Download TV SideView app to your mobile device.
2. Turn on the receiver and then connect it to the same network as your mobile device.
3. Turn on TV SideView, and then select [Add device] and follow the screen instructions both on TV SideView and the receiver.

After registration is completed you can control the receiver using TV SideView.

[88] Using Network Features | Using TV SideView to control the receiver from a smartphone or tablet device

Checking the registered TV SideView device (Registered Remote Devices)

You can check the TV SideView devices which are able to control the receiver.

1. Select [Setup] - [Network Settings] from the home menu.
2. Select [Registered Remote Devices].

Note

- You can register up to 5 TV SideView devices. If you want to add a new device when a maximum of 5 devices are set, remove unnecessary devices before adding the new device.

[89] Using Network Features | Using TV SideView to control the receiver from a smartphone or tablet device

Deleting TV SideView device from device list

You can check and delete the TV SideView devices which are able to control the receiver.

1. Select [Setup] - [Network Settings] from the home menu.

2. Select [Registered Remote Devices].
3. Select the device you want to delete and press OPTIONS.
4. Select [Remove] from the options menu.
5. Select [OK].

The selected device is deleted from the device list.

[90] Using Network Features | Using Google Cast™ to enjoy audio content from a smartphone or tablet device

Using Google Cast™ to enjoy audio content from a smartphone or tablet device

Google Cast allows you to select music content from the Google Cast-enabled app and play back via this receiver. Google Cast needs to be set up initially using “SongPal.”

1. Download “SongPal” to the device.
 2. Start “SongPal,” and then connect the device wirelessly to the same network as that of the receiver.
 3. Follow the instructions on “SongPal” to configure the initial settings on the device.
 4. Start the Google Cast-enabled app on the device, and then select the AV device to playback content.
-

[91] Using Network Features | Setting whether to control this receiver from a device on the home network

Setting whether to control this receiver from a controller device on the home network (Renderer Access Control)

You can check a list of products compatible with a controller on the home network and set whether or not each product is accessible via this receiver.

1. Select [Setup] - [Network Settings] from the home menu.

2. Select [Renderer Access Control].
A list of registered controllers appears (up to 40 devices).
3. Select the controller you want to set and press \leftarrow .
4. Select the setting you want.
 - **Allow:** Permits access from the controller.
 - **Block:** Blocks access from the controller.

[92] Using Network Features | Setting whether to control this receiver from a device on the home network

Enabling automatic access from a newly detected controller device (Auto Renderer Access Permission)

You can set whether or not the receiver allows automatic access from a newly detected controller device on the home network.

1. Select [Setup] - [Network Settings] from the home menu.
2. Select [Auto Renderer Access Permission].
3. Select the setting you want.
 - **On**
 - **Off**

[93] Using Network Features | Setting whether to control this receiver from a device on the home network

Deleting devices from the device list in Renderer Access Control

1. Select [Setup] - [Network Settings] from the home menu.
2. Select [Renderer Access Control].

3. Select the device you want to delete and press **OPTIONS**.
4. Select **[Remove]** from the options menu.
5. Select **[OK]**.
The selected device is deleted from the device list.

[94] Using BLUETOOTH Features | About BLUETOOTH Features

What you can do with BLUETOOTH features

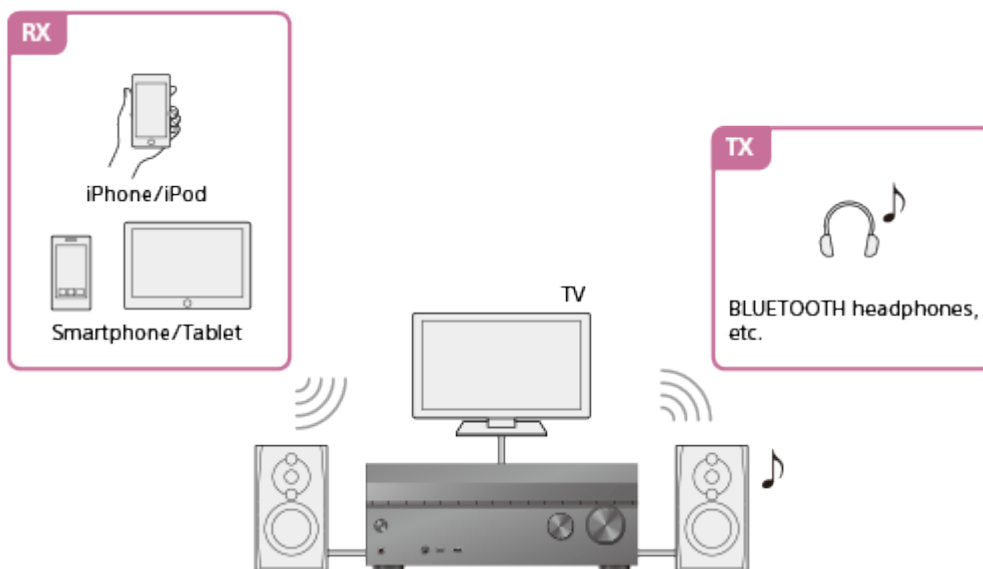

- **RX (Receiver mode)**

Listening to the audio content from a BLUETOOTH device on the receiver

You can receive audio from an iPhone/iPod, smartphone or tablet that has a BLUETOOTH function and listen to it via this receiver.

Devices that have the NFC function can be connected by a one-touch connection simply by bringing the device close to the receiver.

Enjoying audio content stored on a BLUETOOTH device with a one-touch connection (NFC)

Enjoying audio content using the BLUETOOTH function (Pairing operation)

- **TX (Transmitter mode)**

Transmitting sound from AV devices connected to the receiver and listening on a BLUETOOTH receiver

You can enjoy listening to audio from AV devices connected to the receiver through BLUETOOTH headphones. (The NFC function cannot be used.) Move the BLUETOOTH

headphones closer to receiver if sound is intermittent.

Listening with BLUETOOTH headphones (Pairing operation)

See "[Compatible BLUETOOTH version and profiles](#)" for details on BLUETOOTH device versions and profiles that can be paired.

[95] Using BLUETOOTH Features | Enjoying audio content stored on a BLUETOOTH device

Enjoying audio content stored on a BLUETOOTH device with a one-touch connection (NFC)

You can enjoy audio content on a BLUETOOTH device with a one-touch connection using the NFC function.

1. If you are using an NFC-compatible BLUETOOTH device with Android OS 4.0 or earlier, download the "NFC Easy Connect" application to your device.



You do not need to install the "NFC Easy Connect" application if you are using an NFC-compatible BLUETOOTH device with Android OS 4.1 or later installed.

2. Touch the  mark on the receiver with your BLUETOOTH device.

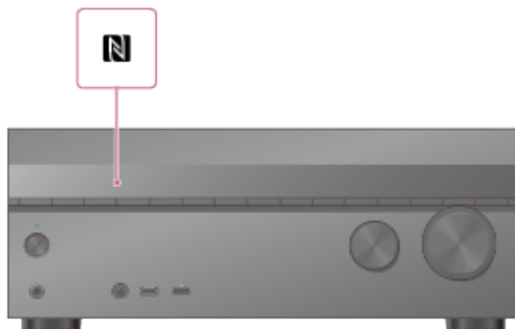

3. Follow the on-screen instructions displayed on the BLUETOOTH device, and complete the procedure for BLUETOOTH connection.
4. Check that the connection is completed and [BT] lights up on the display panel.
5. Start playback on the BLUETOOTH device.
6. Adjust the volume.

Adjust the volume of the BLUETOOTH device first. If the volume level is still too low, adjust the volume level of the receiver.

Compatible smartphones

Smartphones with the NFC function (compatible OS: Android 2.3.3 or later, excluding Android 3.x)

Note

- This function does not work when [Bluetooth Mode] is set to [Off] or while Software Update screen is displayed.
- The receiver does not support BLUETOOTH headphones with NFC function.

Hint

- If you want to connect a BLUETOOTH device when the receiver is in standby mode, set [Quick Start/Network Standby] in the System Settings menu to [On]. (For USA, Canadian and Asia-Pacific models only)

[96] Using BLUETOOTH Features | Enjoying audio content stored on a BLUETOOTH device

Enjoying audio content using the BLUETOOTH function (Pairing operation)

Pairing is an operation where BLUETOOTH devices are registered to each other before connection. Once a pairing operation is performed, it does not need to be performed again. Be sure to set the [Bluetooth Mode] to [Receiver] before pairing a device with this receiver.

1. Place the BLUETOOTH device within 1 meter (3.3 feet) of the receiver.
2. Press and hold CONNECTION PAIRING BLUETOOTH on the receiver to select the BLUETOOTH function.
[PAIRING] flashes on the display panel. Perform step 3 within five minutes, otherwise pairing will be canceled. If pairing is canceled, repeat this step.
3. Perform pairing on the BLUETOOTH device to detect this receiver.
For details, refer to the operating instructions of your BLUETOOTH device.
A list of detected devices may appear on the BLUETOOTH device display depending on the type of BLUETOOTH device. This receiver is displayed as [STR-DN1060] or [STR-DN860].
4. Select [STR-DN1060] or [STR-DN860] on the BLUETOOTH device display.

If [STR-DN1060] or [STR-DN860] is not displayed, repeat this process from step 1.

5. When the BLUETOOTH connection is established, the device name appears and [BT] lights in the display panel.
6. Start playback on the BLUETOOTH device.
7. Adjust the volume.
Adjust the volume of the BLUETOOTH device first. If the volume level is still too low, adjust the volume level of the receiver.

Canceling pairing operation

Switch the input.

Note

- When establishing a connection with this receiver in step 4, select the audio profile (A2DP or AVRCP) on the BLUETOOTH device. If the BLUETOOTH device does not support the AVRCP profile, you cannot perform playback or other operations on the receiver.
- If a passkey is required on the display of the BLUETOOTH device in step 5, enter [0000]. The passkey may be called “Passcode,” “PIN code,” “PIN number” or “Password.”
- You can pair up to 9 BLUETOOTH devices. If a 10th BLUETOOTH device is paired, the least recently connected device will be replaced by the new one.
- CONNECTION PAIRING BLUETOOTH on the receiver does not work when the [Bluetooth Mode] is set to [Off].



Hint

- You can change the name of the receiver that appears on your device in [Device Name] in the System Settings menu.
- On some types of BLUETOOTH devices, you can adjust the volume using the controls of the BLUETOOTH device.

[97] Using BLUETOOTH Features | Enjoying audio content stored on a BLUETOOTH device

Controlling a BLUETOOTH device using the remote control

You can operate a BLUETOOTH device using the following buttons on the remote control:

-  (*): Starts or pauses playback.
-  : Stops playback.
-  : Moves to the start of the previous/current or next track.



* If you press ►|| when no BLUETOOTH device is connected, the receiver automatically connects to the last connected BLUETOOTH device.

Note

- These operations may not be available for certain BLUETOOTH devices. The actual operations may also differ depending on the connected BLUETOOTH device.
- The RX/TX button does not function while the BLUETOOTH function or Screen mirroring function are in use or when [Bluetooth Mode] is set to [Off].

[98] Using BLUETOOTH Features | Enjoying audio content stored on a BLUETOOTH device

Compatible BLUETOOTH version and profiles

“Profile” refers to a standard set of capabilities for various BLUETOOTH product capabilities. This receiver supports the following BLUETOOTH version and profiles:

- **Compatible BLUETOOTH version:** BLUETOOTH Specification Version 3.0
- **Compatible BLUETOOTH profiles:**
 - A2DP (Advanced Audio Distribution Profile): Receives high-quality audio content.
 - AVRCP 1.5 (Audio Video Remote Control Profile): Controls audio/video devices (pausing, stopping, starting playback, volume control, etc.)

For the latest information about compatible BLUETOOTH devices, check the websites listed under “[Customer support websites.](#)”

Note

- The functions may differ depending on the specifications of the BLUETOOTH device.
- The audio playback on this receiver may be delayed from that on the BLUETOOTH device because of the characteristics of the BLUETOOTH wireless technology.

[99] Using BLUETOOTH Features | Listening with BLUETOOTH headphones

Listening with BLUETOOTH headphones (Pairing operation)

You can listen to audio sources playing via this receiver by using BLUETOOTH headphones.

1. Select [Transmitter] in [Bluetooth Mode] from the Bluetooth Settings menu.
[BT TX] appears on the display panel.
2. Turn on the BLUETOOTH function on the BLUETOOTH headphones.
3. Select the name of the BLUETOOTH headphones from the [Device List] in the Bluetooth Settings menu.
If you cannot find the name of your BLUETOOTH headphones in the list, select [Scan].
4. Start playback of the audio source via the receiver.
The sound is output from the BLUETOOTH headphones.
5. Adjust the volume.
Adjust the volume level of the BLUETOOTH headphones first. If the volume level is still too low, adjust the volume level on the receiver. The volume level of the receiver cannot be controlled when BLUETOOTH headphones are connected.  +/- on the remote control and MASTER VOLUME on the receiver only work for the BLUETOOTH headphones.

Note

- You can register up to 9 sets of BLUETOOTH headphones. If a 10th set of BLUETOOTH headphones is registered, the least recently connected BLUETOOTH headphones will be replaced by the new ones.
- The receiver can display up to 15 detected BLUETOOTH headphones in the [Device List].
- You cannot change the sound effects or settings in the options menu while transmitting sound.
- Some content cannot be output due to copyright protection.
- The audio output from the BLUETOOTH headphones may be delayed compared to that from the receiver because of the characteristics of BLUETOOTH wireless technology.
- No sound is output from the speakers or HDMI OUT jacks when BLUETOOTH headphones are successfully connected to the receiver.
- The [Screen mirroring], [Bluetooth] and Home Theatre Control functions are disabled when the receiver is in transmitter mode.
- The receiver does not support BLUETOOTH headphones with the NFC function.

Hint

- You can enable or disable the reception of AAC or LDAC audio from the BLUETOOTH device.
- You can also switch the [Bluetooth Mode] using BLUETOOTH RX/TX on the remote control.
- If the BLUETOOTH device in step 2 is the most recently connected device, you can connect it to the receiver automatically by simply pressing BLUETOOTH RX/TX on the remote control. In this case, you do not need to perform step 3.

Compatible BLUETOOTH version and profiles

“Profile” refers to a standard set of capabilities for various BLUETOOTH product capabilities. This receiver supports the following BLUETOOTH version and profiles:

- **Compatible BLUETOOTH version:** BLUETOOTH Specification Version 3.0
- **Compatible BLUETOOTH profiles:**
 - A2DP (Advanced Audio Distribution Profile): Receives high-quality audio content.
 - AVRCP 1.5 (Audio Video Remote Control Profile): Controls audio/video devices (pausing, stopping, starting playback, volume control, etc.)

For the latest information about compatible BLUETOOTH devices, check the websites listed under “[Customer support websites](#).”

Note

- The functions may differ depending on the specifications of the BLUETOOTH device.
- The audio playback on this receiver may be delayed from that on the BLUETOOTH device because of the characteristics of the BLUETOOTH wireless technology.

Controlling the receiver using a smartphone or tablet device (SongPal)

“SongPal” is a dedicated app for operating SongPal-compatible audio devices manufactured by Sony using a smartphone or tablet device.

Search for “SongPal” on Google Play or the App Store and download to your smartphone or tablet device.

“SongPal” allows you to:

- change commonly used settings, selecting the input of the system and adjusting the volume.
- enjoy music content stored on a home network server or smartphone on the receiver.
- enjoy music visually with your smartphone display.
- configure Wi-Fi connection settings easily using “SongPal” if your Wi-Fi router does not have a WPS function.
- use the SongPal Link function.

1. Download the “SongPal” application to your mobile device.
2. Run “SongPal” and follow the on-screen instructions.
3. Connect your mobile device to the receiver using the NFC function or by manual operation.

After the connection is completed, you can control the receiver using “SongPal.”

Note

- “SongPal” does not support the iPad.
- Before you start to perform the operations above, be sure to set the [Bluetooth Mode] to [Receiver].
- This model is compatible with “SongPal” version 3.0 or later.
- “SongPal” uses the network and BLUETOOTH functions of the receiver.
- Specifications and design of “SongPal” may be changed without prior notice.

[102] Using BLUETOOTH Features | Using “SongPal” to control the receiver from a smartphone or tablet device

Listening to the same music on multiple devices/Listening to different music in a different location (SongPal Link)

You can enjoy music stored on your computer or smartphone or from music services in multiple rooms at the same time.

Refer to the following for details of SongPal Link:

<http://www.sony.net/nasite>

[103] Using the Multi-Zone Features (for STR-DN1060 only) | Overview of multi-zone features (for STR-DN1060 only)

What you can do with multi-zone features (for STR-DN1060 only)

- **Listening in two locations — Zone 2**

You can enjoy audio at the same time in another room by connecting the speakers that are

located in another room to the SURROUND BACK/BI-AMP/FRONT HIGH/FRONT B/ZONE 2 terminals. For example, you can listen to the same music from an AV device located in the living room in both the living room and kitchen, or watch a movie in the living room while music from a different device is played in the kitchen. The volume can be adjusted separately for each room.

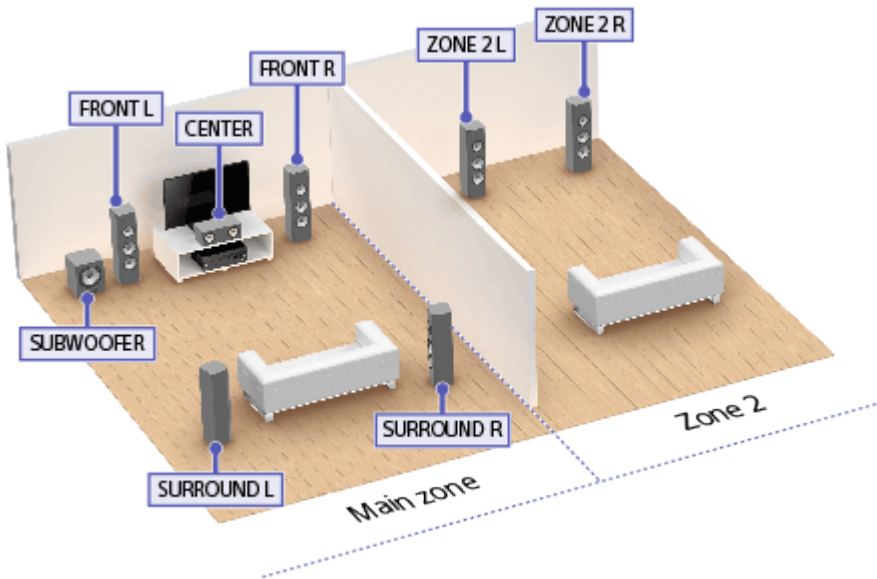

Hint

- Connect one more receiver or amplifier in Zone 2 to the ZONE 2 OUT terminal to enjoy more powerful sound in Zone 2.

- **Listening in three locations — Zone 2 + Zone 3**

In addition to Zone 2, you can enjoy music at the same time in a third room by connecting the speakers located in the third room to the SURROUND/ZONE 3 terminals. For example, audio from an AV device placed in a living room can be played in the kitchen and a terrace at the same time, or different content can be played in each of the three rooms.

The volume can be adjusted separately for each room.

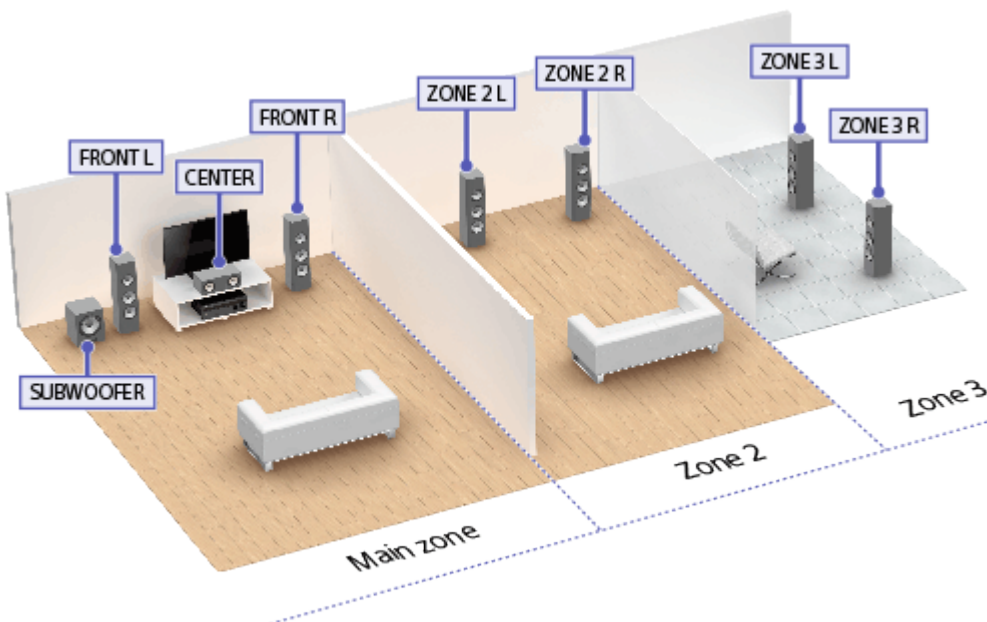

- **HDMI zone**

You can enjoy movies and music in another room by connecting a TV or different AV receiver located in another room to the HDMI OUT B/HDMI ZONE terminals. For example, movies or music from an AV device located in the living room can be played at high quality in a bedroom.

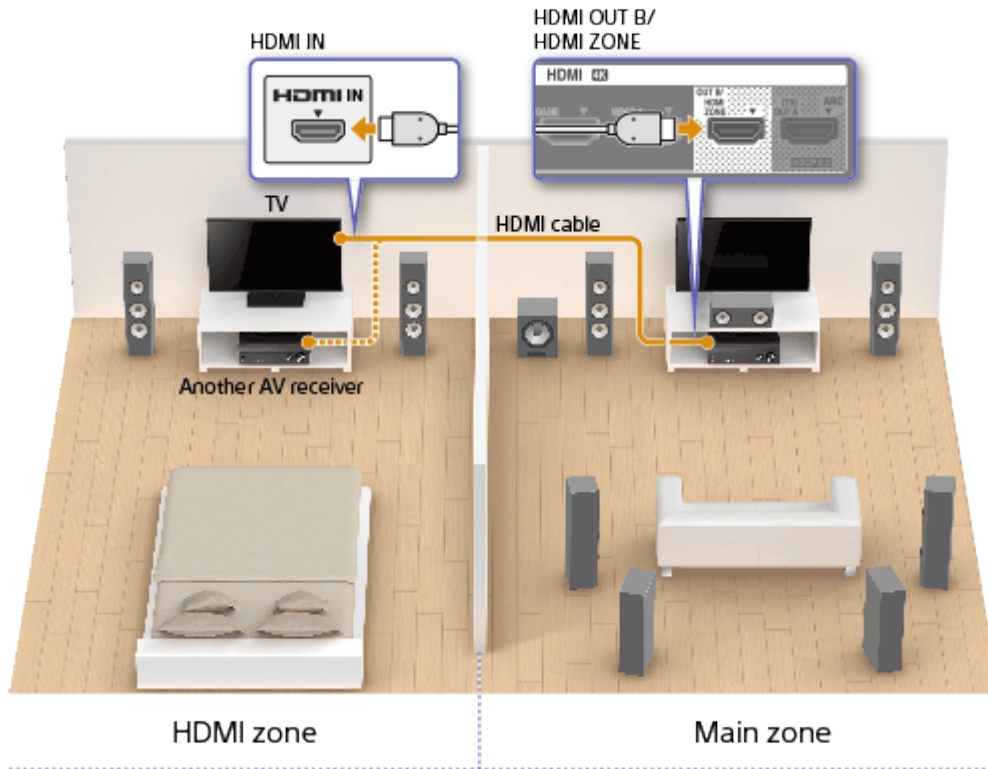

Note

- There are restrictions on the audio sources that can be used in Zone 2/3. For details, see [“Available inputs for each zone \(for STR-DN1060 only\).”](#)

[104] Using the Multi-Zone Features (for STR-DN1060 only) | Overview of multi-zone features (for STR-DN1060 only)

Available inputs for each zone (for STR-DN1060 only)

Available inputs vary depending on the zone you have selected.

Available inputs for main zone

You can select all input source from every device connected to the receiver in the main zone.

Additionally, you can select a sound source received via BLUETOOTH connection.

BD/DVD:

- Source signal from the HDMI IN BD/DVD jack

SAT/CATV:

- Source signal from the HDMI IN SAT/CATV jack
- Source signal from the VIDEO/AUDIO IN SAT/CATV jacks
- Source signal from the COMPONENT VIDEO IN SAT/CATV jacks
- Source signal from the OPTICAL IN 1 (SAT/CATV) jack

GAME:

- Source signal from the HDMI IN GAME jack

SA-CD/CD:

- Source signal from the HDMI IN SA-CD/CD jack
- Source signal from the COAXIAL IN SA-CD/CD jack
- Source signal from the AUDIO IN SA-CD/CD jacks

VIDEO 1:

- Source signal from the HDMI IN VIDEO 1 jack
- Source signal from the VIDEO/AUDIO IN VIDEO 1 jacks

VIDEO 2:

- Source signal from the HDMI/MHL (VIDEO 2 IN) jack on the front panel

USB:

- Source signal from the ψ (USB) port on the front panel

TV:

- TV sound from the OPTICAL IN 2 (TV) jack
- Source signal from the AUDIO IN TV jacks

FM TUNER:

- FM broadcasts received through the built-in tuner

Bluetooth:

- Source signal received via BLUETOOTH

Home Network:

- Source signal on the home network

Available inputs for Zone 2 and/or Zone 3

The following inputs are available for Zone 2 and/or Zone 3.

You cannot watch video in Zone 2 and/or Zone 3. Sound is not available from devices connected to the HDMI IN jacks.

SOURCE:

- Signals from the current input in main zone (sound only)

SAT/CATV:

- Source signal from the AUDIO IN SAT/CATV jacks

VIDEO 1:

- Source signal from the AUDIO IN VIDEO 1 jacks

SA-CD/CD:

- Source signal from the AUDIO IN SA-CD/CD jacks

FM TUNER:

- FM broadcasts received through the built-in tuner

USB (*):

- Source signal from the ψ (USB) port on the front panel

Bluetooth (*):

- Source signal received via BLUETOOTH

Home Network (*):

- Source signal on the home network

Note

- Signals from the HDMI IN, OPTICAL IN and COAXIAL IN jacks cannot be output to the speakers in Zone 2 or Zone 3.
- If you select [Screen mirroring] in the main zone when the current input in Zone 2 or Zone 3 is [USB], [Home Network], [Music Services] or [Bluetooth], the input for Zone 2 and Zone 3 will change to [SOURCE]. In this case, no sound is output to Zone 2 or Zone 3.
- If you connect BLUETOOTH headphones to the main zone while an AV device is playing and the current input in Zone 2 or Zone 3 is [USB], [Home Network] or [Music Services], the input for Zone 2 and Zone 3 will change to [SOURCE]. In this case, only FM tuner and analog audio signal are output to Zone 2 or Zone 3.
- If you connect BLUETOOTH headphones to the main zone while an AV device is playing, the BLUETOOTH headphones will be disconnected if you select [USB], [Home Network] or [Music Services] in Zone 2 or Zone 3.

* You can select either [USB], [Home Network], [Music Services] or [Bluetooth] from the main zone, Zone 2 and Zone 3. Priority is given to the choice which has most recently been selected, even if a different choice has already been selected in one of the zones.

Available inputs for HDMI zone

The following inputs are available for HDMI zone. You can only watch video or listen to audio input from the HDMI IN jacks.

SOURCE:

- Signals from the current input in main zone (sources input from the HDMI IN jacks only)

BD/DVD (*):

- Source signal from the HDMI IN BD/DVD jack

GAME:

- Source signal from the HDMI IN GAME jack

SAT/CATV:

- Source signal from the HDMI IN SAT/CATV jack

VIDEO 1:

- Source signal from the HDMI IN VIDEO 1 jack

VIDEO 2:

- Source signal from the HDMI/MHL (VIDEO 2 IN) jack on the front panel

SA-CD/CD (*):

- Source signal from the HDMI IN SA-CD/CD jack

* You can select either [BD/DVD] or [SA-CD/CD] from the main zone and HDMI Zone. Priority is given to the choice which has most recently been selected, even if a different choice has already been selected in one of the zones.

[105] Using the Multi-Zone Features (for STR-DN1060 only) | Enjoying sound from speakers located in other rooms (for STR-DN1060 only)

1. Connecting the speakers in Zone 2 and/or Zone 3 (for STR-DN1060 only)

You can enjoy sound from a device connected to the receiver in a zone other than the main zone. For example, it is possible to play a CD in Zone 2 while playing a DVD in the main zone.

Place the speakers in Zone 2 and connect them to SPEAKERS SURROUND BACK/BI-AMP/FRONT HIGH/FRONT B/ZONE 2 terminals as illustrated below.

Be sure to disconnect the AC power cord (mains lead) before connecting cables. For details on how to connect speaker cables to the receiver, see "[How to connect speaker cables.](#)"

Connecting the speakers in Zone 2

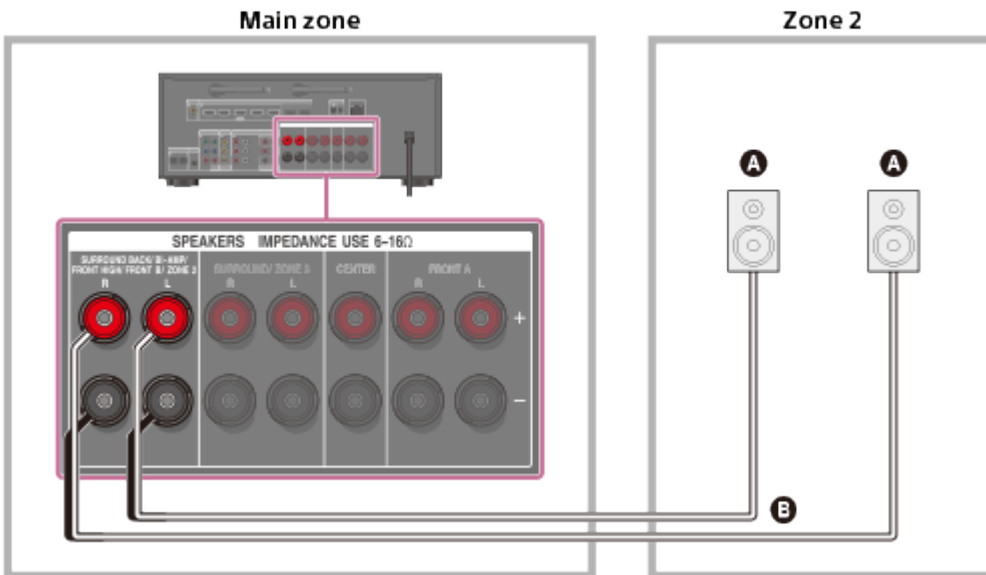

- A Speakers**
- B Speaker cable (not supplied)**

Note

- When using this Zone 2 connection, you need to set up the SPEAKERS SURROUND BACK/BI-AMP/FRONT HIGH/FRONT B/ZONE 2 terminals.
- Only audio signals from [USB], [Bluetooth] (while in BLUETOOTH RX mode only), [Home Network], [Music Services], [FM TUNER] and audio signals input from AUDIO IN jacks are output to the Zone 2 speakers.
- External digital input from OPTICAL IN, COAXIAL IN, HDMI IN jacks and Screen mirroring cannot be output to Zone 2.

Connecting the speakers in Zone 3

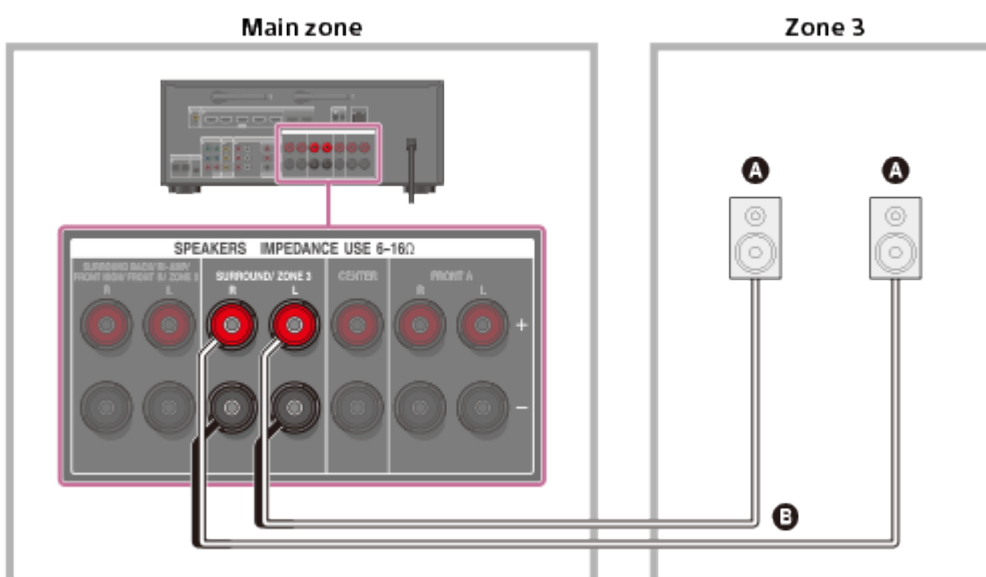

- A Speakers**
- B Speaker cable (not supplied)**



Note

- When using this Zone 3 connection, you need to set up the SPEAKERS SURROUND/ZONE 3 terminals.
- Only audio signals from [USB], [Bluetooth] (while in BLUETOOTH RX mode only), [Home Network], [Music Services], [FM TUNER] and audio signals input from AUDIO IN jacks are output to the Zone 3 speakers.
- External digital input from OPTICAL IN, COAXIAL IN, HDMI IN jacks and Screen mirroring cannot be output to Zone 3.

[106] Using the Multi-Zone Features (for STR-DN1060 only) | Enjoying sound from speakers located in other rooms (for STR-DN1060 only)

2. Assigning speakers for Zone 2 (for STR-DN1060 only)

You can assign the speakers installed in Zone 2 as Zone 2 speakers.

Follow the procedure below after connecting the speakers installed in Zone 2 to the SPEAKERS SURROUND BACK/BI-AMP/FRONT HIGH/FRONT B/ZONE 2 terminals of the receiver.

1. Select [Setup] - [Speaker Settings] from the home menu.
2. Select [Speaker Pattern].
3. Select one of the following speaker patterns displayed on the TV screen: 3/2.1, 3/2, 2/2.1, 2/2, 3/0.1, 3/0, 2/0.1 or 2/0, and select [Save].
4. Select [Sur Back SP Assign] - [Zone2].

Note

- If a speaker pattern with surround back speakers or front high speakers is set, you cannot set the SPEAKERS SURROUND BACK/BI-AMP/FRONT HIGH/FRONT B/ZONE 2 terminals for a bi-amplifier connection or a Zone 2 connection.

[107] Using the Multi-Zone Features (for STR-DN1060 only) | Enjoying sound from speakers located in other rooms (for STR-DN1060 only)

3. Assigning speakers for Zone 3 (for STR-DN1060 only)

You can assign the speakers installed in Zone 3 as Zone 3 speakers.

Follow the procedure below after connecting the speakers installed in Zone 3 to the SURROUND/ZONE 3 terminals of the receiver.

1. Select [Setup] - [Speaker Settings] from the home menu.
2. Select [Speaker Pattern].
3. Select one of the following speaker patterns displayed on the TV screen: 3/0.1, 3/0, 2/0.1 or 2/0, and select [Save].
4. Select [Surround SP Assign] - [Zone3].

Note

- You cannot set the SURROUND/ZONE 3 terminals for a Zone 3 connection if a speaker pattern with surround speakers is set.

[108] Using the Multi-Zone Features (for STR-DN1060 only) | Enjoying sound from speakers located in other rooms (for STR-DN1060 only)

4. Enjoying sound in Zone 2 and/or Zone 3 (for STR-DN1060 only)

You can enjoy sound from the receiver in Zone 2 and/or Zone 3 by the following procedure.

1. Press ZONE SELECT on the receiver repeatedly to select Zone 2 or Zone 3.
2. Press ZONE POWER on the receiver.
The selected zone is activated.
3. Select the source signals you want to output using INPUT SELECTOR on the receiver while [2. xxxx (input name)] or [3. xxxx (input name)] is shown on the display panel.
Select [SOURCE] if you want to listen to the same sound as main zone in Zone 2 or Zone 3.
4. Start playing the desired audio content on the selected input device.
5. Adjust to a suitable volume.
Adjust the volume using MASTER VOLUME on the receiver while [2. xxxx (input name)] or [3. xxxx (input name)] is shown on the display panel.

Hint

If [2. xxxx (input name)] or [3. xxxx (input name)] disappears in step 3, press ZONE SELECT again.

To exit zone operation

Press ZONE SELECT on the receiver repeatedly to select the zone you want to exit, then press ZONE POWER.

Available input for zone operations

See “[Available inputs for each zone \(for STR-DN1060 only\).](#)”

Hint

- A dedicated App for this model “SongPal” enables easier zone operation such as changing the settings or switching the zone inputs from your smartphone or tablet.

[109] Using the Multi-Zone Features (for STR-DN1060 only) | Enjoying sound from speakers located in other rooms using another amplifier (for STR-DN1060 only)

1. Connecting another amplifier in Zone 2 (for STR-DN1060 only)

You can enjoy sound from a device connected to the receiver in a zone other than the main zone. For example, you can watch a DVD in the main zone and listen to a CD in Zone 2.

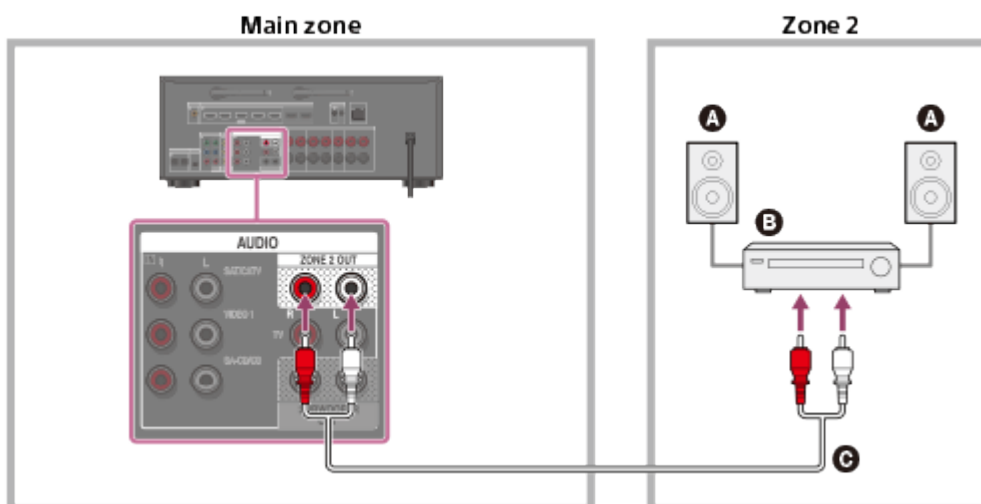

- Ⓐ Speakers
- Ⓑ Amplifier/receiver
- Ⓒ Audio cable (not supplied)

Note

Only audio signals from [USB], [Bluetooth] (only when in BLUETOOTH RX mode), [Home Network], [Music Services], [FM TUNER] and audio signals input from AUDIO IN jacks are output to the Zone 2 speakers.

- External digital input from OPTICAL IN, COAXIAL IN, HDMI IN jacks and Screen mirroring cannot be output to Zone 2.

[110] Using the Multi-Zone Features (for STR-DN1060 only) | Enjoying sound from speakers located in other rooms using another amplifier (for STR-DN1060 only)

2. Setting the volume control for Zone 2 (Zone2 Line Out) (for STR-DN1060 only)

You can set variable or fixed volume control for the ZONE 2 AUDIO OUT jacks.

1. Select [Setup] - [Zone Settings] from the home menu.
2. Select [Zone2 Line Out].
3. Select the setting you want.
 - **Variable:**
Recommended when using another amplifier that does not have volume control for Zone 2.
The volume for the ZONE 2 AUDIO OUT jacks can be changed.
 - **Fixed:**
Recommended when using another amplifier with variable volume control for Zone 2. The volume for the ZONE 2 AUDIO OUT jacks is fixed.

Note

- When [Variable] is set, the volume is turned down by default. Turn up the volume while listening to the sound after completing setup. The volume for the SPEAKERS SURROUND BACK/BI-AMP/FRONT HIGH/FRONT B/ZONE 2 terminals is changed together with the volume for the ZONE 2 AUDIO OUT jacks.

[111] Using the Multi-Zone Features (for STR-DN1060 only) | Enjoying sound from speakers located in other rooms using another amplifier (for STR-DN1060 only)

3. Enjoying sound using another amplifier in Zone 2 (for STR-DN1060 only)

You can enjoy sound from the receiver in Zone 2 by the following procedure.

1. Turn on the amplifier in Zone 2.
2. Press ZONE SELECT on the receiver repeatedly to select Zone 2.
3. Press ZONE POWER on the receiver.
Zone 2 is activated.
4. Select the source signals you want to output using INPUT SELECTOR on the receiver while [2. xxxx (input name)] is shown on the display panel.
5. Adjust to a suitable volume.
Adjust the volume using the receiver in Zone 2. If you set [Zone2 Line Out] to [Variable], you can also adjust the volume in Zone 2 using MASTER VOLUME on the receiver while [2. xxxx (input name)] is shown on the display panel.

Hint

- If [2. xxxx (input name)] disappears in step 4, press ZONE SELECT again.

To exit Zone 2 operation

Press ZONE SELECT on the receiver repeatedly to select the zone you want to exit, then press ZONE POWER while [2. xxxx (input name)] is shown on the display panel.

Available input for Zone 2 operations

See “[Available inputs for each zone \(for STR-DN1060 only\).](#)”

Hint

- A dedicated App for this model “SongPal” enables easier zone operation such as changing the settings or switching the zone inputs from your smartphone or tablet.

[112] Using the Multi-Zone Features (for STR-DN1060 only) | Enjoying video and sound in another room using a TV or another receiver (for STR-DN1060 only)

1. Connecting another amplifier or TV in the HDMI zone (for STR-DN1060 only)

HDMI input video/audio signals are output in HDMI zone using the HDMI OUT B/HDMI ZONE jack of the receiver.

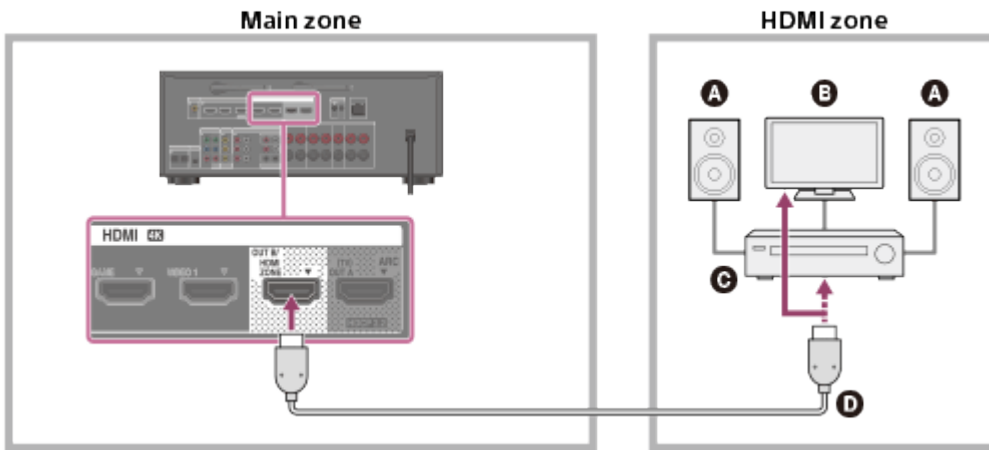

- **A** Speakers
- **B** TV
- **C** Amplifier/receiver
- **D** HDMI cable (not supplied)

Note

- To use this connection, set [HDMI Out B Mode] in the HDMI Settings menu to [Zone].

[113] Using the Multi-Zone Features (for STR-DN1060 only) | Enjoying video and sound in another room using a TV or another receiver (for STR-DN1060 only)

2. Selecting the method to use the HDMI OUT B jack (HDMI Out B Mode) (for STR-DN1060 only)

The HDMI OUT B/HDMI ZONE jack can be used for HDMI zone.

1. Select [Setup] - [HDMI Settings] from the home menu.
2. Select [HDMI Out B Mode].
3. Select the setting you want.
 - **Main:** Uses the jack for HDMI OUT B. Recommended when you enjoy TV or projector content in only one room (main zone).
 - **Zone:** Uses the jack for HDMI zone. Recommended when enjoying video and sound from a device connected to the receiver in another room (HDMI zone).

Note

- When [Zone] is selected, the Control for HDMI function and Fast View function do not

work. For details on selecting the HDMI zone input, see “[4. Enjoying video and sound in another location by connecting another amplifier or TV using HDMI connections \(HDMI zone\) \(for STR-DN1060 only\).](#)”

[114] Using the Multi-Zone Features (for STR-DN1060 only) | Enjoying video and sound in another room using a TV or another receiver (for STR-DN1060 only)

3. Setting the priority for the main zone (Priority) (for STR-DN1060 only)

If you select the same HDMI input for the main zone and HDMI zone when the HDMI zone function is enabled, there may be some interference to the audio and video signals in the main zone. To avoid possible interference, you can place priority on the main zone for HDMI input selection.

1. Select [Setup] - [HDMI Settings] from the home menu.
2. Select [Priority].
3. Select the setting you want.
 - **Main & Zone:**
You can enjoy the same input in the main zone and HDMI zone. However, there may be some interference between the audio and video signals in the main zone and those in the HDMI zone.
 - **Main Only:**
You can enjoy good audio and video quality in the main zone. However, if the same input is selected in HDMI zone, there will be no video or audio output from HDMI zone.

Note

- This function works only when [HDMI Out B Mode] is set to [Zone].

Hint

- If you connect TVs that have different resolutions to the main zone and HDMI zone but select the same HDMI input for both zones, the lower of the two resolutions is used for the video signals output to both TVs.
-

[115] Using the Multi-Zone Features (for STR-DN1060 only) | Enjoying video and sound in

another room using a TV or another receiver (for STR-DN1060 only)

4. Enjoying video and sound in another location by connecting another amplifier or TV using HDMI connections (HDMI zone) (for STR-DN1060 only)

You can enjoy sound from the receiver in the HDMI zone by following the steps below.

1. Turn on the amplifier or TV in the HDMI zone.
2. Press ZONE SELECT on the receiver repeatedly to select the HDMI zone.
3. Press ZONE POWER on the receiver.
The HDMI zone is activated.
4. Select the source signals you want to output using INPUT SELECTOR on the receiver while [H. xxxx (input name)] is shown on the display panel.
5. Adjust to a suitable volume.
Adjust the volume using the volume control of the amplifier or TV in the HDMI zone.
The receiver cannot adjust the volume in the HDMI zone.

Hint

- If [H. xxxx (input name)] disappears in step 4, press ZONE SELECT again.

To exit HDMI zone operation

Press ZONE SELECT on the receiver repeatedly to select the zone you want to exit, then press ZONE POWER while [H. xxxx (input name)] is shown on the display panel.

Available input for HDMI zone operations

See "[Available inputs for each zone \(for STR-DN1060 only\)](#)."

Hint

- A dedicated App for this model "SongPal" enables easier zone operation such as changing the settings or switching the zone inputs from your smartphone or tablet.

[116] Using Other Features | Interlocking with BRAVIA TV and other devices ("BRAVIA" Sync)

What is "BRAVIA" Sync?

The “BRAVIA” Sync function allows communication between Sony products such as TVs, Blu-ray Disc players, DVD players, and AV amplifiers that support the Control for HDMI function.

Control for HDMI is a mutual control function standard used by HDMI CEC (Consumer Electronics Control) for HDMI (High-Definition Multimedia Interface).

We recommend that you connect the receiver to products featuring “BRAVIA” Sync.

[117] Using Other Features | Interlocking with BRAVIA TV and other devices (“BRAVIA” Sync)

Preparing for “BRAVIA” Sync

Turn the Control for HDMI function on to use the "BRAVIA" Sync function. The Control for HDMI function needs to be turned on separately for the receiver and the connected device.

1. Select [Setup] - [HDMI Settings] from the home menu.
2. Select [Control for HDMI].
3. Select [On].
The Control for HDMI function of the receiver is turned on.
4. Press HOME to return to the home menu.
5. Press HOME again to exit the home menu.
6. Select the HDMI input of the receiver to match the HDMI input of the connected device, so that the image from the connected device is displayed.
7. Turn on the Control for HDMI function of the connected device.
For details on setting the connected device, refer to the operating instructions of the respective devices.
8. Repeat steps 6 and 7 for other devices for which you want to use the Control for HDMI function.

Note

- Perform the steps above again if you unplug the HDMI cable or change the connection.
- This function works only when [HDMI Out B Mode] is set to [Main]. (for STR-DN1060 only)

[118] Using Other Features | Interlocking with BRAVIA TV and other devices (“BRAVIA” Sync)

Enjoying an input source from a connected device immediately (One-Touch Play)

When you play content on a device connected to the receiver via an HDMI connection, the receiver is also automatically turned on and switched to the appropriate HDMI input.

Note

- Depending on the TV, the start of the content may not appear.
- If you set [Standby Through] to [Auto] or [On], and then play back the content on a connected device when the receiver is in standby mode, sound and image can only be output from the TV while the receiver remains in standby mode.

[119] Using Other Features | Interlocking with BRAVIA TV and other devices (“BRAVIA” Sync)

Enjoying TV sound from the speakers connected to the receiver (System Audio Control)

You can use the System Audio Control function as follows:

- The TV sound is output from the speakers connected to the receiver when the receiver is turned on. If you turn off the receiver, the sound is output from the TV speaker.
- When you adjust the TV volume, the System Audio Control function adjusts the volume of the receiver simultaneously.

Note

- When [Control for HDMI] is set to [On], the [Audio Out] settings in the HDMI Settings menu will be set automatically based on the TV speaker settings.

Hint

- You can also operate this function by changing the TV speaker settings. For details, refer to the operating instructions of the TV.
-

Turning off the receiver and connected devices simultaneously with the TV (System Power-Off)

If the TV, receiver and any connected devices are connected to each other via HDMI connections, you can turn them off simultaneously by pressing  on the remote control of the TV.

Note

- Turn on the power supply interlock function of the TV before using the System Power-Off function. For details, refer to the operating instructions of the TV.
 - Some connected devices may not be turned off depending on their specifications. For details, refer to the operating instructions of the connected device.
-

Selecting the optimum picture quality and sound field automatically (Scene Select)

The optimum picture quality and sound field are selected automatically according to the scene selected on your TV.

For details on this operation, refer to the operating instructions of the TV.

Switching the sound field for the scene selected on your TV (Scene: Sound field)

- **Cinema:** HD-D.C.S.
- **Sports:** Sports
- **Music:** Live Concert
- **Animation:** A.F.D.
- **Photo:** A.F.D.
- **Game:** A.F.D.
- **Graphics:** A.F.D.

Note

- The sound field may not change depending on some TVs.

[122] Using Other Features | Interlocking with BRAVIA TV and other devices (“BRAVIA” Sync)

About Home Theatre Control

If a Home Theatre Control-compatible TV is connected to the receiver, an icon for Internet based applications appears on the connected TV.

You can switch an input of the receiver or switch sound fields by using the remote control of your TV. You can also adjust the level of the center speaker or the subwoofer, or adjust the settings of [Sound Optimizer], [Dual Mono], or [A/V Sync].

Note

- Your TV must be able to access a broadband service to use the Home Theatre Control function.

[123] Using Other Features | Interlocking with BRAVIA TV and other devices (“BRAVIA” Sync)

Operating the receiver menu using the TV remote control (Remote Easy Control)

You can use the remote control of the TV to operate the menu of the receiver. For details, refer to the operating instructions of the TV.

Note

- The receiver is recognized as [Tuner] by the TV.
- Your TV must support the link menu.
- Some of the operations may not be available depending on the type of TV.

[124] Using Other Features | Interlocking with BRAVIA TV and other devices (“BRAVIA” Sync)

About Controlling MHL devices

By connecting an MHL device with an MHL cable (not supplied), you can use One-Touch Play and Remote Easy Control.

These functions allow communication with Sony “BRAVIA” Sync-compatible TVs using an HDMI cable (not supplied).

Note

- These functions may not work depending on the connected MHL device.











One-Touch Play

The receiver switches to the appropriate input when you connect, play content, etc. from your MHL device.

Note

- This function can only work when:
 - The receiver is turned on.
 - [Control for HDMI] is set to [On].
 - [MHL Auto Input] is set to [On].
 - The MHL device is connected via an MHL cable (not supplied) to the HDMI/MHL (VIDEO 2 IN) (for STR-DN1060 only) or HDMI IN SAT/CATV (MHL) jack.

Remote Easy Control

You can use the ///, , BACK, OPTIONS, HOME (*),  , , and  

* Hold down HOME to display the home menu of the MHL device.

Note

- This function can only work when:
 - The receiver is turned on.
 - The MHL device is connected via an MHL cable (not supplied) to the HDMI/MHL (VIDEO 2 IN) (for STR-DN1060 only) or HDMI IN SAT/CATV IN (MHL) jack.

[125] Using Other Features | Enjoying video and sound with your desired way of use

Switching the monitors that output the HDMI video signals (for STR-DN1060 only)

If you have connected two monitors to the HDMI OUT A (TV) and HDMI OUT B/HDMI ZONE jacks, you can switch the output for these two monitors using the HDMI OUTPUT button on the remote control.

1. Turn on the receiver and the two monitors.

2. Press HDMI OUTPUT.

Each time you press the button, the output will be switched as follows:

HDMI A - HDMI B - HDMI A+B - HDMI OFF

Note

- [HDMI A+B] may not work if the compatible video formats of the monitors connected to the HDMI OUT A (TV) jack and the HDMI OUT B/HDMI ZONE jack of the receiver are different.
- [HDMI A+B] may not work depending on the playback device you connect.
- The TV screen menu is available only on monitors connected to the HDMI OUT A (TV) jack.
- Even if you select [HDMI OFF], HDMI signals are output to the HDMI zone.

[126] Using Other Features | Enjoying video and sound with your desired way of use

Switching between digital and analog audio (Input Mode)

When you connect devices to both digital and analog audio input jacks on the receiver, you can fix the audio input mode to either device, or switch from one to the other, depending on the type of material you intend to watch.

1. Press the input buttons to select the input.

2. Press OPTIONS.

3. Select [Input Mode].

- **Auto:** Gives priority to digital audio signals. If there is more than one digital connection, HDMI audio signals have priority.
If there are no digital audio signals, analog audio signals are selected. When TV input is selected, priority is given to Audio Return Channel (ARC) signals. If your TV does not support the ARC function, digital optical audio signals are selected.
- **Optical:** Specifies input of digital audio signals to the OPTICAL jack.
- **Coaxial:** Specifies input of digital audio signals to the COAXIAL jack.
- **Analog:** Specifies input of analog audio signals to the AUDIO IN (L/R) jacks.

Note

Depending on the input, [Input Mode] may be dimmed on the TV screen and other modes cannot be selected.

- When [Analog Direct] is being used, audio input is set to [Analog]. You cannot select other modes.

Hint

- You can also use INPUT SELECTOR on the receiver to select the input in step 1.

[127] Using Other Features | Enjoying video and sound with your desired way of use

Using other video/audio input jacks (Input Assign)

You can reassign the COMPONENT VIDEO (*) and OPTICAL/COAXIAL digital audio input jacks to other input if the default settings of the jacks do not correspond to your connected device.

E.g. When connecting a DVD player to the OPTICAL IN 1 (SAT/CATV) and COMPONENT VIDEO IN SAT/CATV jacks of the STR-DN1060:

- Assign the OPTICAL IN 1 (SAT/CATV) jack to [BD/DVD].
- Assign the COMPONENT VIDEO IN SAT/CATV jacks to [BD/DVD].

1. Select [Setup] - [Input Settings] from the home menu.
2. Select the input name you want to assign.
3. Press \leftarrow/\rightarrow repeatedly to select [COMPONENT] (*) or [OPTICAL / COAXIAL].
4. Press \uparrow/\downarrow repeatedly to select the jack you want to assign.

* For STR-DN1060 only

Assignable video input jacks (for STR-DN1060 only)

IN:

BD/DVD, GAME, SAT/CATV (*), VIDEO 1, VIDEO 2, SA-CD/CD

None:

BD/DVD (*), GAME (*), SAT/CATV, VIDEO 1 (*), VIDEO 2 (*), SA-CD/CD (*)

Assignable audio input jacks

OPT 1:

STR-DN1060: BD/DVD, GAME, SAT/CATV (*), VIDEO 1, VIDEO 2, SA-CD/CD

STR-DN860: BD/DVD, GAME, SAT/CATV (*), VIDEO, SA-CD/CD

OPT 2:

STR-DN1060: BD/DVD, GAME, SAT/CATV, VIDEO 1, VIDEO 2, SA-CD/CD

STR-DN860: BD/DVD, GAME, SAT/CATV, VIDEO, SA-CD/CD

COAX:

STR-DN1060: BD/DVD, GAME, SAT/CATV, VIDEO 1, VIDEO 2, SA-CD/CD (*)

STR-DN860: BD/DVD, GAME, SAT/CATV, VIDEO, SA-CD/CD (*)

None:

STR-DN1060: BD/DVD (*), GAME (*), SAT/CATV, VIDEO 1 (*), VIDEO 2 (*), SA-CD/CD

STR-DN860: BD/DVD (*), GAME (*), SAT/CATV, VIDEO (*), SA-CD/CD

* Default setting

Note

- When you assign the digital audio input, the Input Mode setting may change automatically.
- One reassignment is allowed for each input.
- If no sound is output from the assigned jacks, also check the Input Mode settings.

[128] Using Other Features | Saving and recalling various settings for the receiver (Custom Preset)

About Custom Preset

You can save various settings with the player, monitor, etc., according to your listening and viewing style. You can register those settings for “one-touch” operation, and then recall the environment created with the settings easily.

For example, by saving the settings in the [1: Movie] preset as follows, you can switch the settings of the receiver all at one time without switching each setting for [Input], [Sound Field] and [Calibration Type] individually.

- Input: BD/DVD
- Sound Field: HD-D.C.S.
- Calibration Type: No Change

[129] Using Other Features | Saving and recalling various settings for the receiver (Custom Preset)

Saving the settings to a preset

1. Select [Custom Preset] from the home menu.
2. Press OPTIONS with a preset for which you want to edit settings among from [1: Movie], [2: Music], [3: Party] or [4: Night] selected.
3. Select the menu you want from the options menu.
 - **Edit:**
Allows you to customize and save the settings to suit your preferences.
 - **Import:**
Loads the present settings of the receiver and saves those settings as a preset. [Input] and [Volume] are not saved.

Note

- Settings items saved as [No Change] are not changed from the present settings even when you recall the preset. Select [Edit], then uncheck the box for a setting item on the edit screen to set [No Change].

Hint

- You can overwrite [1: Movie], [2: Music] or [3: Party] with the present settings by holding down CUSTOM PRESET 1, CUSTOM PRESET 2 or CUSTOM PRESET 3 for 3 seconds in the same way as you do when you select [Import] from the menu.
- When you select [3: Party], Zone 2, Zone 3 and HDMI zone are turned on automatically allowing you to enjoy the same music that is playing in the main zone. (for STR-DN1060 only)

[130] Using Other Features | Saving and recalling various settings for the receiver (Custom Preset)

Recalling the settings saved to the scene

1. Select [Custom Preset] from the home menu.
2. Select a preset you want.

Hint

- You can recall the setting(s) saved for [1: Movie], [2: Music] or [3: Party] directly by pressing CUSTOM PRESET 1, CUSTOM PRESET 2, or CUSTOM PRESET 3 on the remote control.

Items for which you can save settings and the default values for each item

1: Movie

- Input: BD/DVD
- Tuner Preset: –
- Volume: –
- HDMI Output: –
- Party Mode (for STR-DN1060 only): –
- Sleep: –
- Sound Field: HD-D.C.S.
- Sound Optimizer: –
- In-Ceiling Speaker Mode: –
- Pure Direct: –
- Calibration Type: –
- Front Bass: –
- Front Treble: –
- Center Bass: –
- Center Treble: –
- Surround Bass: –
- Surround Treble: –
- Front High Bass: –
- Front High Treble: –

2: Music

- Input: SA-CD/CD
- Tuner Preset: –
- Volume: –
- HDMI Output: –
- Party Mode (for STR-DN1060 only): –
- Sleep: –
- Sound Field: Multi Stereo
- Sound Optimizer: –
- In-Ceiling Speaker Mode: –
- Pure Direct: –
- Calibration Type: –
- Front Bass: –
- Front Treble: –

- Center Bass: –
- Center Treble: –
- Surround Bass: –
- Surround Treble: –
- Front High Bass: –
- Front High Treble: –

3: Party

- Input: –
- Tuner Preset: –
- Volume: 27
- HDMI Output: –
- Party Mode (for STR-DN1060 only): On
- Sleep: Off
- Sound Field: Multi Stereo
- Sound Optimizer: Off
- In-Ceiling Speaker Mode: –
- Pure Direct: –
- Calibration Type: –
- Front Bass: –
- Front Treble: –
- Center Bass: –
- Center Treble: –
- Surround Bass: –
- Surround Treble: –
- Front High Bass: –
- Front High Treble: –

4: Night

- Input:–
- Tuner Preset: –
- Volume: 11
- HDMI Output: –
- Party Mode (for STR-DN1060 only): –
- Sleep: 30 min
- Sound Field: –
- Sound Optimizer: Normal
- In-Ceiling Speaker Mode: –
- Pure Direct: –
- Calibration Type: –
- Front Bass: –
- Front Treble: –
- Center Bass: –
- Center Treble: –

- Surround Bass: –
 - Surround Treble: –
 - Front High Bass: –
 - Front High Treble: –
-

[132] Using Other Features | Using the sleep timer

Using the sleep timer (Sleep)

You can set the receiver to turn off automatically at a specified time.

1. Select [Setup] - [System Settings] from the home menu.
2. Select [Sleep].
3. Set specified time.
 - 2:00:00
 - 1:30:00
 - 1:00:00
 - 0:30:00
 - Off

[SLEEP] lights up on the display panel of the receiver when sleep timer is being used.

Hint

- You can check the remaining time before the receiver turns off on the System Settings screen. Also, the remaining time appears on the bottom right of the TV screen when it becomes 1 minute or less.
 - The sleep timer will be canceled if you perform the following:
 - Update the software of the receiver.
 - Turn the receiver on or off.
-

[133] Using Other Features | Checking information on the receiver

Viewing information on the display panel

The display panel provides various information on the status of the receiver, such as the sound field.

1. Select the input for which you want to check information.
2. Press DISPLAY MODE on the receiver repeatedly.
Each time you press DISPLAY MODE, the display will change cyclically as follows:
Index name of the input (*1) - Input you selected - Sound field currently applied (*2) -
Volume level - Stream information (*3)

When listening to FM radio

Preset station name (*1) - Frequency - Sound field currently applied (*2) - Volume level

When receiving RDS broadcasts (for European and Asia-Pacific models only)

Program service name or preset station name (*1) - Frequency, band and preset number - Sound field currently applied (*2) - Volume level

*1 Index name appears only when you have assigned one to the input or preset station. Index name does not appear if only blank spaces have been entered or it is same as the input name.

*2 [PURE.DIRECT] appears on the display panel when the Pure Direct function is activated.

*3 Stream information may not be displayed.

Note

- Characters or marks in some languages may not be displayed.

[134] Adjusting Settings | Easy Setup

Setting up the receiver using Easy Setup

When you turn on the receiver for the first time or after the receiver is initialized, the Easy Setup screen appears on the TV screen. You can set up the following settings for the receiver by following the instructions on the Easy Setup screen.

- **Speaker Settings**

Check your speaker system and perform automatic calibration according to the configuration and arrangement of your speaker system.

- **Internet Settings**

Configure settings to connect the receiver to the network.

Note

- Switch the input of the TV to the input to which the receiver is connected to use this function.
- Auto Calibration is not available when [Bluetooth Mode] is set to [Transmitter].

If the Easy Setup screen does not appear or you want to display the Easy Setup screen manually, you can display it by selecting [Setup] - [Easy Setup] from the home menu.

[135] Adjusting Settings | Speaker Settings

1. About Auto Calibration

Auto Calibration allows you to perform automatic calibration as follows.

- Check the connection between each speaker and the receiver.
- Adjust the speaker level.
- Measure the distance of each speaker from your seating position. (*)
- Measure the speaker size. (*)
- Measure the frequency characteristics (EQ). (*)
- Measure the frequency characteristics (Phase). (*)(**)

* The measurement result is not utilized when [Analog Direct] is selected.

** The measurement result may be not utilized, depending on the audio formats.

Note

- The D.C.A.C. is designed to achieve proper sound balance for your room. However, you can adjust the speaker levels manually according to your preference using [Test Tone].
-

[136] Adjusting Settings | Speaker Settings

2. Before you perform Auto Calibration

Before you perform Auto Calibration, check the following items:

- Set up and connect the speakers.
 - Do not connect any microphones other than the supplied optimizer microphone to the AUTO CAL MIC jack.
 - If using a bi-amplifier connection or speakers with a front B connection, set the assignment for the SPEAKERS SURROUND BACK/BI-AMP/FRONT HIGH/FRONT B terminals properly.
 - Set the speaker output to a setting other than [SPK OFF].
 - Disconnect the headphones.
 - Remove any obstructions between the optimizer microphone and the speakers.
 - For accurate measurement, make sure the environment is quiet and free from noise.
-

Note

- Auto Calibration is not available when [Bluetooth Mode] is set to [Transmitter].
- The speakers emit very loud sound during the calibration and the volume cannot be adjusted. Be considerate of your neighbors and any children who are present.
- If the muting function has been activated before you perform Auto Calibration, the muting function will shut off automatically.
- It may not be possible to take the correct measurements or to perform Auto Calibration at all if special speakers such as dipole speakers are used.

[137] Adjusting Settings | Speaker Settings

3. Connecting the optimizer microphone

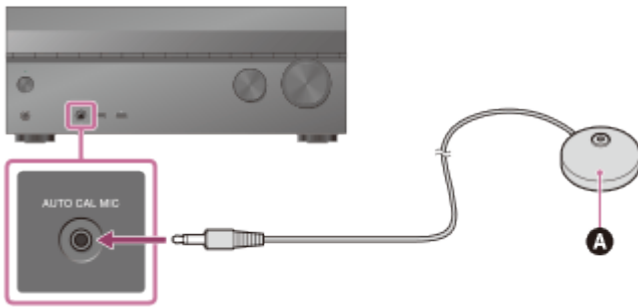

A Optimizer microphone (supplied)

1. Connect the supplied optimizer microphone to the AUTO CAL MIC jack.
2. Set up the optimizer microphone.
Place the optimizer microphone where you will sit and set it at the same height as your ears.

[138] Adjusting Settings | Speaker Settings

4. Selecting the front speakers

You can select the front speakers you want to operate.

Be sure to use the buttons on the receiver to perform this operation.

1. Press SPEAKERS on the receiver repeatedly to select the front speaker system you want to operate.

SPEAKERS



The indicators on the display panel shows which set of terminals are selected.

- **SP A :**
Speakers connected to the SPEAKERS FRONT A terminals.
- **SP B (*):**
Speakers connected to the SPEAKERS SURROUND BACK/BI-AMP/FRONT HIGH/FRONT B terminals.
- **SP A+B (*):**
Speakers connected to both the SPEAKERS FRONT A and SPEAKERS SURROUND BACK/BI-AMP/FRONT HIGH/FRONT B terminals (parallel connection).
- **(None):**
[SPK OFF] appears on the display panel. No audio signals are output from any speaker terminals.

* To select [SP B] or [SP A+B], set the assignment for the SPEAKERS SURROUND BACK/BI-AMP/FRONT HIGH/FRONT B terminals to [Front B] by using [Sur Back SP Assign] in the Speaker Settings menu.

Note

- This setting is not available when headphones are connected.
- When you press SPEAKERS on the receiver, the [Bluetooth Mode] changes to [Receiver] automatically.

[139] Adjusting Settings | Speaker Settings

5. Performing Auto Calibration

You can perform automatic calibration from where you are sitting.

1. Select [Setup] - [Speaker Settings] from the home menu.
2. Select [Auto Calibration].

3. Follow the instructions on the TV screen, then press **↵** to select [Start].
The measurement starts in 5 seconds.
The measurement process will take approximately 30 seconds with a test tone.
When the measurement ends, a beep sounds and the screen switches.

4. Select the item you want.

- **Save:** Saves the measurement results and exits the setting process.
- **Retry:** Performs the Auto Calibration again.
- **Discard:** Exits the setting process without saving the measurement results.

For details on the measurement results, see “[6. Checking Auto Calibration results.](#)”

5. Save the measurement results.

Select [Save] in step 4.

Note

- If an error code or warning message appears on the screen in step 3, see “[List of messages after Auto Calibration measurements.](#)”
- This setting is not available when headphones are connected.

Hint

- The Auto Calibration function will be canceled if you perform the following during the measurement process:
 - Press **⏻**.
 - Press the input buttons on the remote control or turn INPUT SELECTOR on the receiver.
 - Press **⌂**.
 - Press SPEAKERS on the receiver.
 - Change the volume level.
 - Connect headphones.

[140] Adjusting Settings | Speaker Settings

6. Checking Auto Calibration results

To check error codes or warning messages received in [Auto Calibration], proceed with the following steps:

If an error code appears

Check the error and perform Auto Calibration again.

1. Select [Retry].

2. Follow the instructions on the TV screen and then press \downarrow to select [Start].
The measurement starts in five seconds.
The measurement process will take approximately 30 seconds with a test tone.
When the measurement ends, a beep sounds and the screen switches.
3. Select the item you want.
 - **Save:** Saves the measurement results and exits the setting process.
 - **Retry:** Performs the Auto Calibration again.
 - **Discard:** Exits the setting process without saving the measurement results.
4. Save the measurement results.
Select [Save] in step 3.

If a warning message appears

Check the warning message and select [OK]. For details on the warning messages, see “[List of messages after Auto Calibration measurements.](#)”

Hint

- The measurement results may vary depending on the position of the subwoofer.
However, continuing to use the receiver with that value does not cause problems.

[141] Adjusting Settings | Speaker Settings

Calibrating the phase characteristics of the speakers (A.P.M. (Automatic Phase Matching))

You can set the A.P.M. (Automatic Phase Matching) function in the D.C.A.C. (Digital Cinema Auto Calibration). This calibrates the phase characteristics of the speakers for well-coordinated surround sound.

1. Select [Setup] - [Speaker Settings] from the home menu.
2. Select [Automatic Phase Matching].
3. Select the setting you want.
 - **Auto:** Switches the A.P.M. function on or off automatically.
 - **Off**

Note

- This function does not work in the following cases:
 - [Analog Direct] is being used.
 - Headphones are connected.
 - [Auto Calibration] has not been performed.
 - [Bluetooth Mode] is set to [Transmitter]
 - The receiver may play signals at a lower sampling frequency than the actual sampling frequency of the input signals, depending on the audio format.
-

[142] Adjusting Settings | Speaker Settings

Selecting the Auto Calibration type (Calibration Type)

You can select a calibration type after you have performed the Auto Calibration and saved the settings.

1. Select [Setup] - [Speaker Settings] from the home menu.
2. Select [Calibration Type].
3. Select the setting you want.
 - **Full Flat:** Makes the measurement of frequency from each speaker flat.
 - **Engineer:** Sets to “the Sony listening room standard” frequency characteristics.
 - **Front Reference:** Adjusts the characteristics of all of the speakers to match the characteristics of the front speaker.
 - **Off**

Note

- This function does not work in the following cases:
 - [Analog Direct] is being used.
 - Headphones are connected.
 - [Bluetooth Mode] is set to [Transmitter]
 - The receiver may play signals at a lower sampling frequency than the actual sampling frequency of the input signals, depending on the audio format.
-

[143] Adjusting Settings | Speaker Settings

Setting how to assign the surround speaker terminals (Speaker Pattern/Surround SP Assign) (for STR-DN1060)

only)

You can select the speaker pattern for the SPEAKERS SURROUND terminals and set how to assign the terminals.

1. Select [Setup] - [Speaker Settings] from the home menu.
2. Select [Speaker Pattern].
3. Select the desired speaker pattern according to the speaker installation example displayed on the TV screen, then select [Save].
4. Set [Surround SP Assign] to any of the following settings (*).
 - **Zone3**: When using the Zone 3 connection.
 - **Off**

* The displayed settings vary depending on the speaker pattern you selected in step 3.

Note

- You can only set [Surround SP Assign] under the following conditions:
 - The speaker pattern is set to a setting without surround speakers.
 - Headphones are not connected.
 - [Bluetooth Mode] is set to other than [Transmitter].

[144] Adjusting Settings | Speaker Settings

Selecting the speaker pattern and setting the assignment for the speaker terminals (Speaker Pattern/Sur Back SP Assign)

You can select the speaker pattern and set the assignment for the SPEAKERS SURROUND BACK/BI-AMP/FRONT HIGH/FRONT B terminals.

1. Select [Setup] - [Speaker Settings] from the home menu.
2. Select [Speaker Pattern].
3. Select the desired speaker pattern according to the speaker installation example displayed on the TV screen, then select [Save].

4. Set [Sur Back SP Assign] to any of the following settings (*).

- **Zone2** (for STR-DN1060 only)
When using the Zone 2 connection.
- **Bi-Amp**
When using the bi-amplifier connection.
- **Front B**
When using the front B speaker connection.
- **Off**
When none of the connections above are used.

* The displayed settings vary depending on the speaker pattern you selected in step 3.

Note

- You can only set [Sur Back SP Assign] under the following conditions:
 - The speaker pattern is set to a setting without surround back and front high speakers.
 - Headphones are not connected.
 - [Bluetooth Mode] is set to other than [Transmitter].

[145] Adjusting Settings | Speaker Settings

Adjusting the speaker size (Size)

You can adjust the size of each speaker (front left/right, front high left/right, center, surround left/right, surround back left/right).

1. Select [Setup] - [Speaker Settings] from the home menu.
 2. Select [Size].
 3. Select the speaker on the screen for which you want to adjust the size.
 4. Select the size you want.
 - **Large:** If you connect large speakers that will effectively reproduce bass frequencies, select [Large]. Select [Large] usually.
 - **Small:** If the sound is distorted, or you hear a lack of surround effects when using multi channel surround sound, select [Small]. You can activate the bass redirection circuitry and output the bass frequencies of each channel from the subwoofer or other [Large] speakers.
-

Note

- [Size] cannot be set in the following cases:
 - Headphones are connected.
 - [Bluetooth Mode] is set to [Transmitter].

Hint

- The surround back speakers will be set to the same setting as that of the surround speakers.
- When the front speakers are set to [Small], the center, surround, and surround back/front high speakers are also automatically set to [Small].
- If you do not use the subwoofer, the front speakers are automatically set to [Large].

[146] Adjusting Settings | Speaker Settings

Adjusting the speaker distance (Distance)

You can adjust the distance from where you are sitting to each speaker (front left/right, front high left/right, center, surround left/right, surround back left/right, subwoofer).

1. Select [Setup] - [Speaker Settings] from the home menu.
2. Select [Distance].
3. Select the speaker on the screen for which you want to adjust the distance from where you are sitting.
4. Adjust the distance.

Note

- Some parameters may not be available depending on the speaker pattern setting.
- [Distance] cannot be set in the following cases:
 - Headphones are connected.
 - [Bluetooth Mode] is set to [Transmitter].

[147] Adjusting Settings | Speaker Settings

Adjusting the speaker level (Level)

You can adjust the level of each speaker (front left/right, front high left/right, center, surround left/right, surround back left/right and subwoofer).

1. Select [Setup] - [Speaker Settings] from the home menu.
2. Select [Level].
3. Select the speaker on the screen for which you want to adjust the speaker level.
4. Adjust the level.

Note

- This function is not available when [Bluetooth Mode] is set to [Transmitter].
- If headphones are connected, only Front L Level and Front R Level are available.

[148] Adjusting Settings | Speaker Settings

Outputting a test tone from each speaker (Test Tone)

You can output a test tone from each speaker in sequence.

1. Select [Setup] - [Speaker Settings] from the home menu.
2. Select [Test Tone].
3. Select the setting you want.
 - **Off**
 - **Auto:** The test tone is output from each speaker in sequence.
 - **Front L, Center, Front R, Surround R, Surround L, Sur Back L, Sur Back (*), Sur Back R, Front High L, Front High R, Subwoofer:** You can select which speakers will output the test tone.

* [Sur Back] appears when only one surround back speaker is connected.

4. Adjust the speaker level.

Note

- This function is not available when [Bluetooth Mode] is set to [Transmitter].

Hint

- To adjust the level of all speakers at the same time, press  +/- . You can also use MASTER VOLUME on the receiver.

- The adjusted value is shown on the TV screen during adjustment.

To output a test tone from adjacent speakers

See “[Adjusting the balance between adjacent speakers by outputting a test tone \(Phase Noise\)](#).”



To output the source sound from adjacent speakers

See “[Adjusting the balance between adjacent speakers by outputting a source sound \(Phase Audio\)](#).”

[149] Adjusting Settings | Speaker Settings

Setting the crossover frequency of the speakers (Crossover Frequency)

You can set the bass crossover frequency of speakers for which the speaker size has been set to [Small] in the Speaker Settings menu. A measured speaker crossover frequency is set for each speaker after the Auto Calibration is performed.

1. Select [Setup] - [Speaker Settings] from the home menu.
2. Select [Crossover Frequency].
3. Select the speaker for which you want to adjust the crossover frequency on the screen.
4. Press / to set the crossover frequency.

Note

- This function does not work in the following cases:
 - Headphones are connected.
 - [Bluetooth Mode] is set to [Transmitter].
- The surround back speakers will be set to the same setting as that of the surround speakers.

[150] Adjusting Settings | Speaker Settings

Adjusting the equalizer (Equalizer)

You can use the following parameters to adjust the tonal quality (bass/treble level) of the front, center, surround/surround back and front high speakers.

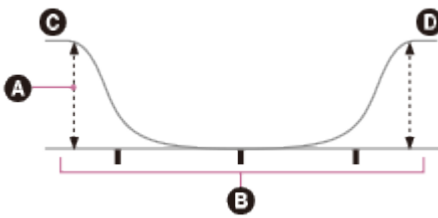

- A** Level (dB)
- B** Frequency (Hz)
- C** Bass
- D** Treble

1. Select [Setup] - [Speaker Settings] from the home menu.
2. Select [Equalizer].
3. Select [Front], [Center], [Surround] or [Front High].
4. Select [Bass] or [Treble].
5. Adjust the gain.

Note

- This function does not work in the following cases:
 - [Analog Direct] is being used.
 - [Pure Direct] is set to [On].
 - [Bluetooth Mode] is set to [Transmitter].
- Frequencies for [Bass] and [Treble] are fixed.
- Depending on the audio format, the receiver may play signals at a lower sampling frequency than the original sampling frequency of the input signals.
- Only [Bass] gain and [Treble] gain are available for [Front] when headphones are connected.

Hint

- You can also select [Equalizer] in [Sound Effects] from the home menu.

By using the front high speakers, you can lift up the sounds of the center speaker to an appropriate height on the screen, allowing you to enjoy natural sound without discomfort.

1. Select [Setup] - [Speaker Settings] from the home menu.
2. Select [Center Speaker Lift Up].
3. Select the setting you want.
 - **1 - 10**
 - **Off**

Note

- This function does not work in the following cases:
 - Headphones are connected.
 - There is no center speaker.
 - There are no front high speakers.
 - The [2ch Stereo], [Analog Direct] and [Multi Stereo] sound fields are being used.
 - A sound field for music is being used.
 - [Bluetooth Mode] is set to [Transmitter].

[152] Adjusting Settings | Speaker Settings

Setting the height from the floor to the ceiling speakers (Ceiling Speaker Height)

Set the height from the floor to the ceiling speakers. You can enjoy the [In-Ceiling Speaker Mode] function more by configuring this setting and performing Auto Calibration.

1. Select [Setup] - [Speaker Settings] from the home menu.
2. Select [Ceiling Speaker Height].
3. Adjust the height.

Note

- This function does not work in the following cases:
 - A speaker pattern that includes front high speakers is selected.
 - Headphones are connected.

– [Bluetooth Mode] is set to [Transmitter].

[153] Adjusting Settings | Speaker Settings

Selecting the unit of measurement (Distance Unit)

You can select the unit of measurement for setting distances.

1. Select [Setup] - [Speaker Settings] from the home menu.
2. Select [Distance Unit].
3. Select the setting you want.
 - **meter:** The distance is displayed in meters.
 - **feet:** The distance is displayed in feet.

[154] Adjusting Settings | Audio Settings

Playing audio signals with high-quality sound (Digital Legato Linear (D.L.L.))

The D.L.L. function is Sony proprietary technology that allows low-quality digital and analog audio signals to be played with high-quality sound.

1. Select [Setup] - [Audio Settings] from the home menu.
2. Select [Digital Legato Linear].
3. Select the setting you want.
 - **Auto 1:** This function is available for lossy compression audio formats and analog audio signals.
 - **Auto 2:** This function is available for Linear PCM signals, as well as lossy compression audio formats and analog audio signals.
 - **Off**

Note

- This function may not work on some content via a USB device or home network.
- This function works when [2ch Stereo], [A.F.D.], [Multi Stereo] or [Headphone(2ch)] is selected. However, this function does not work in the following cases:
 - The [In-Ceiling Speaker Mode] function is being used.
 - [FM TUNER] is selected as the input.
 - Linear PCM signals with a sampling frequency other than 44.1 kHz are being received.
 - Dolby Digital Plus, Dolby Digital EX, Dolby TrueHD, DTS 96/24, DTS-ES Matrix 6.1, DTS-HD Master Audio or DTS-HD High Resolution Audio signals are being received.
 - [Bluetooth Mode] is set to [Transmitter].

[155] Adjusting Settings | Audio Settings

Enjoying clear and dynamic sound at a low volume (Sound Optimizer)

You can enjoy clear and dynamic sound at low volume levels using the Sound Optimizer. After the Auto Calibration is performed, the sound level is optimized to suit your environment.

1. Select [Setup] - [Audio Settings] from the home menu.
2. Select [Sound Optimizer].
3. Select the setting you want.
 - **Normal:** Adjusts for the reference level of a movie.
 - **Low:** Adjusts for a CD or other software whose average sound pressure level is processed highly.
 - **Off**

Note

- This function does not work in the following cases:
 - [Analog Direct] is being used.
 - [Pure Direct] is set to [On].
 - Headphones are connected.
 - [Bluetooth Mode] is set to [Transmitter].
- The receiver may play signals at a lower sampling frequency than the actual sampling frequency of the input signals, depending on the audio format.

Hint

- You can also select [Sound Optimizer] in [Sound Effects] from the home menu.

Selecting a sound field (Sound Field)

You can select from a variety of sound field modes according to speaker connections or input sources.

1. Select [Setup] - [Audio Settings] from the home menu.
2. Select [Sound Field].
3. Select the sound field you want.
For movies, select a sound field labeled with [Movie].
For music, select a sound field labeled with [Music].

Note

- You cannot select sound effects when [Bluetooth Mode] is set to [Transmitter].
- When listening with headphones, only the sound fields for headphones appear.
- The sound fields for movie and music may not work, depending on the input or the speaker pattern you select, or with audio formats.
- The receiver may play signals at a lower sampling frequency than the actual sampling frequency of the input signals, depending on the audio format.
- [PLIIx Movie] or [PLIIx Music] may not appear, depending on the speaker pattern you select.
- Some speakers or the subwoofer may not output sound, depending on the sound field setting.

Hint

- You can also select [Sound Field] in [Sound Effects] from the home menu.
- You can also use A.F.D./2CH, MOVIE or MUSIC on the remote control or the receiver to select a sound field.

Selecting the HD-D.C.S. effect type (HD-D.C.S. Type)

Select the HD-D.C.S. effect type you want.

1. Select [Setup] - [Audio Settings] from the home menu.

2. Select [HD-D.C.S. Type].
3. Select the setting you want.
 - **Dynamic**
 - **Theater**
 - **Studio**

Note

- This function works only when the sound field is set to [HD-D.C.S. Type].
- This function does not work in the following cases:
 - Headphones are connected.
 - [Bluetooth Mode] is set to [Transmitter].

[158] Adjusting Settings | Audio Settings

Enjoying more natural sound with speakers installed in the ceiling (In-Ceiling Speaker Mode)

Set whether or not to use in-ceiling speaker mode with the current input.

In a setup where the front and center speakers are installed in the ceiling, lowering the audio output position to the screen height allows you to enjoy a more natural experience.

1. Select [Setup] - [Audio Settings] from the home menu.
2. Select [In-Ceiling Speaker Mode].
3. Select [On].

Note

- This function does not work in the following cases:
 - A speaker pattern with the front high speakers is selected.
 - Headphones are connected.
 - [Bluetooth Mode] is set to [Transmitter].
 - [Pure Direct] is set to [On].
- This function does not work if you select a sound field other than the following:
 - 2ch Stereo
 - A.F.D.: Auto Format Direct
 - Multi Stereo

- This function may not work depending on the audio format.
- The receiver may play signals at a lower sampling frequency than the actual sampling frequency of the input signals depending on the audio format.

Hint

- You can also select [In-Ceiling Speaker Mode] in [Sound Effects] from the home menu.
- To obtain the optimal sound for your listening environment, configure the [Ceiling Speaker Height] setting in the Speaker Settings menu, then perform Auto Calibration.

[159] Adjusting Settings | Audio Settings

Enjoying high-fidelity sound (Pure Direct)

You can enjoy higher-fidelity sound from all inputs using the Pure Direct function. When the Pure Direct function is on, the display panel lights off to suppress noise that affects sound quality.

1. Select [Sound Effects] - [Pure Direct] from the home menu.
2. Select [On].

Canceling Pure Direct

The Pure Direct function will be canceled when you perform the following:

- Select [Off] in step 2.
- Press PURE DIRECT on the receiver.
- Change the sound field.
- Change the scene setting on the TV (Scene Select).
- Change the setting of [Equalizer], [Sound Optimizer], [Advanced Auto Volume], [Dynamic Range Compressor], [In-Ceiling Speaker Mode], [Automatic Phase Matching], [Calibration Type] or [LFE Time Alignment].

Note

- [Equalizer], [Sound Optimizer], [Advanced Auto Volume], [Dynamic Range Compressor], [In-Ceiling Speaker Mode], [Automatic Phase Matching], [Calibration Type] and [LFE Time Alignment] do not work when the Pure Direct function is selected.

Hint

- You can also use the PURE DIRECT button on the receiver to turn the Pure Direct function on or off.
- You can also select [Pure Direct] in [Setup] - [Audio Settings] from the home menu.

Setting the low-pass filter for the subwoofer output (Subwoofer Low Pass Filter)

You can turn the low-pass filter for the subwoofer output on or off. You can set the function for each input to which an audio input jack is assigned independently. Turn the function on if you connect a subwoofer without the crossover frequency function.

1. Select [Setup] - [Audio Settings] from the home menu.
2. Select [Subwoofer Low Pass Filter].
3. Select the setting you want.
 - **On:** Always activates the low-pass filter with a cutoff frequency of 120 Hz.
 - **Off:** Does not activate the low-pass filter.

Note

- This function does not work in the following cases:
 - [Analog Direct] is being used.
 - [Bluetooth Mode] is set to [Transmitter].

Synchronizing audio with video output (A/V Sync)

You can delay the output of audio to minimize the time gap between audio output and a visual display.

This function is useful when using a large LCD or plasma monitor or a projector. You can set the function for each input independently.

1. Select [Setup] - [Audio Settings] from the home menu.
2. Select [A/V Sync].
3. Select the setting you want.
 - **HDMI Auto:** The time gap between the audio output and visual display of a monitor connected via an HDMI connection will be adjusted automatically. This feature is

available only when the monitor supports the A/V Sync function.

- **0 ms – 300 ms:** You can adjust the delay from 0 ms to 300 ms in 10 ms intervals.

Note

- The receiver may play signals at a lower sampling frequency than the actual sampling frequency of the input signals, depending on the audio format.
- This function is not available when [Bluetooth Mode] is set to [Transmitter].

[162] Adjusting Settings | Audio Settings

Time-aligning the LFE (low frequency effect) channel (LFE Time Alignment)

The LFE Time Alignment function allows you to shift the output timing of the LFE channel forward for other channels. This function is effective for adjusting content in which there is a gap between the LFE channel phase and other channel phases.

1. Select [Setup] - [Audio Settings] from the home menu.
2. Select [LFE Time Alignment].
3. Select the setting you want.
 - **0 ms – 20 ms:** You can adjust the gap from 0 ms to 20 ms in 0.5 ms intervals.

Note

- This function does not work in the following cases:
 - [Pure Direct] is set to [On].
 - [2ch Stereo] or [Analog Direct] is being used.
 - Headphones are connected.
 - A speaker pattern without the subwoofer is selected.
 - The front speaker size is set to [Small].
 - No LFE signal is input.
 - [Bluetooth Mode] is set to [Transmitter].

[163] Adjusting Settings | Audio Settings

Adjusting the volume automatically (Advanced Auto

Volume)

This receiver can adjust its volume automatically depending on the input signal or content from a connected device.

This function is useful, for example, when the sound of commercials is louder than a TV program.

1. Select [Setup] - [Audio Settings] from the home menu.
2. Select [Advanced Auto Volume].
3. Set to [On] or [Off].

Note

- Be sure to reduce the volume level before you turn this function on or off.
- The Advanced Auto Volume function may not work, depending on the audio format.
- This function does not work in the following cases:
 - [Analog Direct] is being used.
 - [Bluetooth Mode] is set to [Transmitter].

[164] Adjusting Settings | Audio Settings

Selecting the language of digital broadcasts (Dual Mono)

You can select the language you want when listening to a digital broadcast with dual audio. This function only works for Dolby Digital sources.

1. Select [Setup] - [Audio Settings] from the home menu.
2. Select [Dual Mono].
3. Select the setting you want.
 - **Main:** Sound in the main language will be output.
 - **Sub:** Sound in the sub language will be output.
 - **Main/Sub:** Sound in the main language will be output through the front left speaker and sound in the sub language will be output through the front right speaker simultaneously.

Compressing the dynamic range (Dynamic Range Compressor)

You can compress the dynamic range of the soundtrack. This may be useful when you want to watch movies at a low volume late at night, etc.

This function only works for Dolby Digital and Dolby TrueHD sources.

1. Select [Setup] - [Audio Settings] from the home menu.
2. Select [Dynamic Range Compressor].
3. Select the setting you want.
 - **Auto:** The dynamic range is compressed automatically when there is a flag in the sound source that recommends using the Dynamic Range Compressor function.
 - **On:** The dynamic range is compressed as intended by the recording engineer.
 - **Off**

Setting the screen aspect ratio of the TV (TV Type)

1. Select [Setup] - [Screen Settings] from the home menu.
2. Select [TV Type].
3. Select the setting you want.
 - **16 : 9**
Select this when connecting a wide-screen TV or a TV with a wide-mode function.
 - **4 : 3**
Select this when connecting a 4:3 screen TV without a wide-mode function.

Note

- The [TV Type] setting does not affect video signals from the HDMI IN jacks.

Outputting 24p video signals when watching content from other networks (Network content 24p Output)

1. Select [Setup] - [Screen Settings] from the home menu.
2. Select [Network content 24p Output].
3. Select the setting you want.
 - **Auto:** Outputs 24p video signals only when you connect a 1080/24p-compatible TV via an HDMI connection.
 - **Off:** Select this if your TV is not compatible with 1080/24p video signals.

Enjoying 4K content (4K Output)

You can set whether or not to output 4K video signals via HDMI.

1. Select [Setup] - [Screen Settings] from the home menu.
2. Select [4K Output].
3. Select the setting you want.
 - **Auto1:** Outputs 2K (1920 × 1080) video signals during video playback and 4K video signals during photo play when connected to a 4K-compatible device made by Sony. Outputs 4K video signals during playback of 24p video contents or photo play when connected to a non-Sony 4K-compatible device. This setting does not work for 3D video image playback.
 - **Auto2:** Automatically outputs 4K/24p video signals when you connect a 4K/24p-compatible device and configure the appropriate settings in [Network content 24p Output]. Also outputs 4K/24p photo images when you play 2D photo files.
 - **Off**

- If your Sony device is not detected when [Auto1] is selected, the setting will have the same effect as the [Auto2] setting.
- The [4K Output] setting does not affect video signals from the HDMI IN jacks. If you want to upscale video signals from the HDMI IN jacks to 4K, use [HDMI In 4K Scaling] in HDMI Settings menu.

[169] Adjusting Settings | Screen Settings

Setting the color space conversion for the video signal from HDMI jacks (YCbCr/RGB (HDMI))

1. Select [Setup] - [Screen Settings] from the home menu.
2. Select [YCbCr/RGB (HDMI)].
3. Select the setting you want.
 - **Auto:** Automatically detects the type of external device, and switches to the corresponding color setting.
 - **YCbCr (4 : 2 : 2):** Outputs YCbCr 4:2:2 video signals
 - **YCbCr (4 : 4 : 4):** Outputs YCbCr 4:4:4 video signals.
 - **RGB:** Select this when connecting to a device with an HDCP-compatible DVI jack.

Note

- [YCbCr/RGB (HDMI)] setting does not affect to video signals from the HDMI IN jacks.

Hint

- You can change the setting even when no device is connected via HDMI.
- The setting is maintained even when you disconnect the HDMI cable.

[170] Adjusting Settings | Screen Settings

Outputting the Deep Color video signal from HDMI jacks (HDMI Deep Color Output)

1. Select [Setup] - [Screen Settings] from the home menu.

2. Select [HDMI Deep Color Output].
3. Select the setting you want.
 - **Auto**
 - **12bit:** Outputs 12bit video signals if the connected TV is compatible with Deep Color.
 - **10bit:** Outputs 10bit video signals if the connected TV is compatible with Deep Color.
 - **Off:** Select this if the picture is unstable or the colors appear unnatural.

Note

- This function does not work when [YCbCr/RGB (HDMI)] is set to [RGB]. In this case, the output signal is fixed as RGB.
- The [HDMI Deep Color Output] setting does not affect video signals from the HDMI IN jacks.

[171] Adjusting Settings | Screen Settings

Smoothing the gradation of video signals (SBM (Super Bit Mapping))

The SBM (Super Bit Mapping) is a function that processes and outputs a smooth gradation video signal from the HDMI OUT jack.

1. Select [Setup] - [Screen Settings] from the home menu.
2. Select [SBM].
3. Select the setting you want.
 - **On:** Smoothes the gradation of video signals output from the HDMI OUT jack.
 - **Off:** Select this if distorted video signals or unnatural color is output.

Note

- [SBM] setting does not affect to video signals from the HDMI IN jacks.

[172] Adjusting Settings | HDMI Settings

Upscaling video signals to 4K (HDMI In 4K Scaling)

You can upscale video signals to 4K and output them through the HDMI OUT jacks of the receiver.

1. Select [Setup] - [HDMI Settings] from the home menu.
2. Select [HDMI In 4K Scaling].
3. Select the setting you want.
 - **Auto:** Enables video scaling control of 4K HDMI output automatically if you connect a 4K-compatible TV.
 - **Off**

Note

- This function works only when video signals are received via the HDMI IN jacks. HDMI input signal must be 480p/720p/1080i/1080p 2D signal.
- The HDMI OUT B/HDMI ZONE jack does not support [HDMI In 4K Scaling]. Video signals are output in the same resolution as the input resolution. (for STR-DN1060 only)

[173] Adjusting Settings | HDMI Settings

Controlling HDMI devices (Control for HDMI)

You can turn the Control for HDMI function on or off.

1. Select [Setup] - [HDMI Settings] from the home menu.
2. Select [Control for HDMI].
3. Set to [On] or [Off].

Note

- When you set [Control for HDMI] to [On], [Audio Out] may be changed automatically.
- When the receiver is in standby mode, the I/O (on/standby) indicator on the front panel lights up in amber if [Control for HDMI] is set to [On].
- This function works only when [HDMI Out B Mode] is set to [Main]. (for STR-DN1060 only)

Passing HDMI signals through (Standby Through)

You can output HDMI signals to the TV even when the receiver is in standby mode.

1. Select [Setup] - [HDMI Settings] from the home menu.
2. Select [Standby Through].
3. Select the setting you want.
 - **Auto:** The receiver outputs HDMI signals to the TV from the HDMI OUT jack when the TV is turned on while the receiver is in the standby mode.
Sony recommends this setting if you are using a “BRAVIA” Sync-compatible Sony TV. This setting saves power in the standby mode compared to the [On] setting.
 - **On:** The receiver continuously outputs HDMI signals from the HDMI OUT jack when in standby mode.
 - **Off:** The receiver does not output HDMI signals when in standby mode.
This setting saves power in the standby mode compared to the [On] setting.

Note

- When the receiver is in standby mode, the I/O (on/standby) indicator on the front panel lights up in amber if [Standby Through] is set to [On] or [Auto].
- When [Auto] is selected, it may take a little more time for the image and sound to be output to the TV than when [On] is selected.
- This function does not work for the HDMI OUT B/HDMI ZONE jack. (for STR-DN1060 only)

Setting the HDMI audio signal output of connected devices (Audio Out)

You can set the HDMI audio signal output of playback devices connected to the receiver via an HDMI connection.

1. Select [Setup] - [HDMI Settings] from the home menu.

2. Select [Audio Out].
3. Select the setting you want.
 - **AMP:** HDMI audio signals from playback devices are only output to the speakers connected to the receiver. Multi-channel sound can be played back as it is.
 - **TV + AMP:** The sound is output from the speaker of the TV and the speakers connected to the receiver.

Note

- Audio signals are not output from the speaker of the TV when [Audio Out] is set to [AMP].
- The sound quality of the playback device depends on the sound quality of the TV (number of channels, sampling frequency, etc.). If the TV has stereo speakers, the sound output from the receiver is in the same stereo as the TV, even when playing back multi-channel source.
- When you connect the receiver to a video device (projector, etc.), sound may not be output from the receiver. In this case, select [AMP].
- When you select [TV + AMP], only sound from the HDMI IN jacks is output from the speaker of the TV.

[176] Adjusting Settings | HDMI Settings

Setting the level of the subwoofer (Subwoofer Level)

You can set the level of the subwoofer to 0 dB or +10 dB when PCM signals are input via an HDMI connection. The level for each input to which an HDMI input jack is assigned can be set independently.

1. Select [Setup] - [HDMI Settings] from the home menu.
2. Select [Subwoofer Level].
3. Select the setting you want.
 - **Auto:** Automatically sets the level to 0 dB or +10 dB, depending on the audio stream.
 - **+10 dB**
 - **0 dB**

Note

- This setting is invalid when [FM TUNER], [USB], [Bluetooth], [Home Network], [Music Services] or [Screen mirroring] is selected.

[177] Adjusting Settings | HDMI Settings

Selecting the method to use the HDMI OUT B jack (HDMI Out B Mode) (for STR-DN1060 only)

The HDMI OUT B/HDMI ZONE jack can be used for HDMI zone.

1. Select [Setup] - [HDMI Settings] from the home menu.
2. Select [HDMI Out B Mode].
3. Select the setting you want.
 - **Main:** Uses the jack for HDMI OUT B. Recommended when you enjoy TV or projector content in only one room (main zone).
 - **Zone:** Uses the jack for HDMI zone. Recommended when enjoying video and sound from a device connected to the receiver in another room (HDMI zone).

Note

- When [Zone] is selected, the Control for HDMI function and Fast View function do not work. For details on selecting the HDMI zone input, see [“4. Enjoying video and sound in another location by connecting another amplifier or TV using HDMI connections \(HDMI zone\) \(for STR-DN1060 only\).”](#)

[178] Adjusting Settings | HDMI Settings

Setting the priority for the main zone (Priority) (for STR-DN1060 only)

If you select the same HDMI input for the main zone and HDMI zone when the HDMI zone function is enabled, there may be some interference to the audio and video signals in the main zone. To avoid possible interference, you can place priority on the main zone for HDMI input selection.

1. Select [Setup] - [HDMI Settings] from the home menu.

2. Select [Priority].

3. Select the setting you want.

- **Main & Zone:**

You can enjoy the same input in the main zone and HDMI zone. However, there may be some interference between the audio and video signals in the main zone and those in the HDMI zone.

- **Main Only:**

You can enjoy good audio and video quality in the main zone. However, if the same input is selected in HDMI zone, there will be no video or audio output from HDMI zone.

Note

- This function works only when [HDMI Out B Mode] is set to [Zone].

Hint

- If you connect TVs that have different resolutions to the main zone and HDMI zone but select the same HDMI input for both zones, the lower of the two resolutions is used for the video signals output to both TVs.

[179] Adjusting Settings | HDMI Settings

Speeding up the display when switching the HDMI input (Fast View)

You can set the Fast View function for the HDMI inputs.

1. Select [Setup] - [HDMI Settings] from the home menu.

2. Select [Fast View].

3. Select the setting you want.

- **Auto:** You can select HDMI input faster than normal selection.
- **Off:** The Fast View function is not available.

Note

- This function is enabled only when [HDMI Out B Mode] is set to [Main]. (for STR-DN1060)

only)

- If you select [Off], it takes more time for images to appear after switching the input. However, the sound quality is improved because the receiver receives signals only from the selected HDMI input jack.

[180] Adjusting Settings | HDMI Settings

Automatically switching the input when an MHL device is connected or being played (MHL Auto Input)

This allows you to turn the function that automatically switches input to the MHL device input on or off when the MHL device is played.

1. Select [Setup] - [HDMI Settings] from the home menu.
2. Select [MHL Auto Input].
3. Select [On] or [Off].

Note

- One-Touch Play function may not work depending on the MHL device.

[181] Adjusting Settings | Input Settings

Changing the assignment and display for the input jacks

You can customize the settings for each input according to your preferences and usage. Select [Setup] - [Input Settings] from the home menu, then set each item shown below.

Input

You can change the settings of [Icon], [Name], [Watch / Listen], [Show / Hide], [OPTICAL / COAXIAL], [COMPONENT] (*) and [Input Mode] for each input.

* For STR-DN1060 only

Note

- The settings of [HDMI], [VIDEO IN] and [AUDIO IN] on the Input Settings screen are fixed and cannot be changed.

Icon

You can set the icon displayed on the Watch/Listen menu.

Name

You can change the name displayed on the Watch/Listen menu.

Watch / Listen

You can set whether an input is displayed on the Watch menu or the Listen menu.

- **Watch:** Displays an input to the Watch menu.
- **Listen:** Displays an input to the Listen menu.
- **Watch / Listen:** Displays an input to both the Watch and Listen menus.

Show / Hide

You can set whether or not an input is displayed.

- **Show:** Shows the input.
- **Hide:** Hides the input.

OPTICAL / COAXIAL

You can set the digital audio input jack(s) assigned to each input.

- **OPT 1**
- **OPT 2**
- **COAX**
- **None**

COMPONENT (for STR-DN1060 only)

You can set the video input jack(s) assigned to each input.





- **IN**
- **None**

Input Mode

You can set the input mode for each input.

- **Auto**
- **Optical**
- **Coaxial**
- **Analog**



You can enter up to 8 characters for each input name.

1. Select [Setup] - [Input Settings] from the home menu.
2. Select the input name you want to change.
3. Select [Name].
An on-screen keyboard appears on the TV screen.
4. Press /// and  to select characters one by one to enter the name.
5. Select [Enter].
The name you entered is registered.

[183] Adjusting Settings | Network Settings

Setting up a wired LAN connection

You can set up a wired LAN connection by the following procedure.

1. Select [Setup] - [Network Settings] from the home menu.
2. Select [Internet Settings].
3. Select [Wired Setup].
The screen for selecting the IP address acquisition method appears on the TV screen.
4. Select [Auto].
The system starts connecting to the network.
The confirmation screen appears.
5. Press / to browse information, and then press .
6. Select [Save & Connect].
The system starts connecting to the network. For details, refer to the messages that appear on the TV screen.

If using a fixed IP address

Select [Custom] in step 4 and follow the on-screen instructions.

Hint

- See [Network Connection Status] when checking the network settings.

[184] Adjusting Settings | Network Settings

Setting up a wireless LAN connection

Before performing network settings

When your wireless LAN router (access point) is Wi-Fi Protected Setup (WPS)-compatible, you can easily set the network settings with the WPS button.

If not, you will be required to select or enter the following information. Check the following information in advance.

- The network name (SSID) (*) of the wireless LAN router/access point
- The security key (password) (**) for the network

* SSID (Service Set Identifier) is a name that identifies a particular access point.

** This information should be available from a label on your wireless LAN router/access point, from the operating instructions, from the person who set up your wireless network, or from the information provided by your Internet service provider.

1. Select [Setup] - [Network Settings] from the home menu.
2. Select [Internet Settings].
3. Select [Wireless Setup(built-in)].
4. Select [Wi-Fi Protected Setup (WPS)].
5. Select [Start].
6. Press the WPS button on the access point.
The receiver starts connecting to the network.
After the network settings are complete, [] lights up on the display panel.

If selecting the network name (SSID) you want

Select the network name (SSID) you want in step 4, enter the security key (or passphrase) using the on-screen keyboard, and then select [Enter] to confirm the security key. The receiver starts connecting to the network. For details, refer to the messages that appear on the TV screen.

When manually inputting a fixed IP address

Select [New connection registration] - [Manual registration] in step 4, then follow the on-screen instructions.

If using a (WPS) PIN code

Select [New connection registration] - [(WPS) PIN Method] in step 4, then follow the on-screen instructions.

Hint

- See [Network Connection Status] when checking the network connection status.
-

[185] Adjusting Settings | Network Settings

Checking the network connection status (Network Connection Status)

You can check the current network connection status.

1. Select [Setup] - [Network Settings] from the home menu.
 2. Select [Network Connection Status].
-

[186] Adjusting Settings | Network Settings

Checking whether the network connection has been made properly (Network Connection Diagnostics)

You can run the network diagnostic to check whether the network connection has been made properly.

1. Select [Setup] - [Network Settings] from the home menu.
 2. Select [Network Connection Diagnostics].
 3. Follow the on-screen instructions.
-

[187] Adjusting Settings | Network Settings

Setting the priority radio frequency channel for Screen

mirroring (Screen mirroring RF Setting)

If you are using multiple wireless systems such as wireless LANs (Local Area Networks), the wireless signals may be unstable. In this case, playback stability may be improved by setting the priority radio frequency channel for Screen mirroring.

1. Select [Setup] - [Network Settings] from the home menu.
2. Select [Screen mirroring RF Setting].
3. Select the setting you want.
 - **Auto:** Select this in normal conditions. The receiver automatically selects the better channel for Screen mirroring.
 - **CH1/CH6/CH11:** The selected channel is prioritized for Screen mirroring connections.

[188] Adjusting Settings | Network Settings

Displaying the connected home network server (Connection Server Settings)

You can change the display settings of the connected server, check the connection or remove the server from the list.

1. Select [Setup] - [Network Settings] from the home menu.
2. Select [Connection Server Settings].

[189] Adjusting Settings | Network Settings

Enabling automatic access from a newly detected controller device (Auto Renderer Access Permission)

You can set whether or not the receiver allows automatic access from a newly detected controller device on the home network.

1. Select [Setup] - [Network Settings] from the home menu.
2. Select [Auto Renderer Access Permission].
3. Select the setting you want.
 - **On**
 - **Off**

[190] Adjusting Settings | Network Settings

Setting whether to control this receiver from a controller device on the home network (Renderer Access Control)

You can check a list of products compatible with a controller on the home network and set whether or not each product is accessible via this receiver.

1. Select [Setup] - [Network Settings] from the home menu.
2. Select [Renderer Access Control].

A list of registered controllers appears (up to 40 devices).
3. Select the controller you want to set and press \leftarrow .
4. Select the setting you want.
 - **Allow:** Permits access from the controller.
 - **Block:** Blocks access from the controller.

[191] Adjusting Settings | Network Settings

Checking the registered TV SideView device (Registered Remote Devices)

You can check the TV SideView devices which are able to control the receiver.

1. Select [Setup] - [Network Settings] from the home menu.

2. Select [Registered Remote Devices].

Note

- You can register up to 5 TV SideView devices. If you want to add a new device when a maximum of 5 devices are set, remove unnecessary devices before adding the new device.

[192] Adjusting Settings | Network Settings

Enabling the network function even when this receiver is in standby mode (Remote Start)

1. Select [Setup] - [Network Settings] from the home menu.
2. Select [Remote Start].
3. Set to [On] or [Off].
 - **On:** Allows the receiver to be turned on by a device via the network when the receiver is in standby mode.
 - **Off:** The receiver cannot be turned on by a device via the network.

[193] Adjusting Settings | Network Settings

Turning on the control mode for maintenance (External Control)

You can set whether a dedicated controller (home automation controller) on the home network is allowed to control the receiver.

1. Select [Setup] - [Network Settings] from the home menu.
2. Select [External Control].
3. Set to [On] or [Off].

Selecting the BLUETOOTH mode (Bluetooth Mode)

You can enjoy contents from remote devices on this receiver or listen to sound from this receiver on other devices such as headphones.

1. Select [Setup] - [Bluetooth Settings] from the home menu.
2. Select [Bluetooth Mode].
3. Select the setting you want.
 - **Receiver:** The receiver is in receiver mode which enables it to receive and output audio from the remote device.
 - **Transmitter:** The receiver is in transmitter mode which enables it to send audio to the remote device.
[BT TX] appears on the display panel.
 - **Off:** The BLUETOOTH power is turned off and [Listen] - [Bluetooth] cannot be selected from the home menu. The NFC function is also not available.

Note

- [Bluetooth Mode] cannot be switched while the input of the receiver is set to [BLUETOOTH] or [Screen mirroring].
- No sound is output from the speakers connected to the receiver when [Bluetooth Mode] is set to [Transmitter].
- In [Transmitter] mode, the receiver can send audio to up to 1 device.

Hint

- You can set the transmission data rate for LDAC playback [Wireless Playback Quality] in the Bluetooth Settings menu.
 - If you connect to the receiver from your smartphone while [Transmitter] is selected and no device is connected to the receiver, the setting automatically switches to [Receiver] and you can listen to the sound from your smartphone on the receiver.
 - You can also switch between BLUETOOTH RX mode and BLUETOOTH TX by pressing BLUETOOTH RX/TX button on the remote control.
 - You can adjust the volume of the device from the receiver when [Transmitter] is selected.
-

Checking the BLUETOOTH device list (Device List)

You can check a list of the paired and detected BLUETOOTH receivers when [Bluetooth Mode] is set to [Transmitter]. You can perform pairing with detected devices from the list.

1. Select [Setup] - [Bluetooth Settings] from the home menu.
2. Select [Device List].

Hint

- Select [Scan] to refresh the list.

Setting the Bluetooth Standby mode (Bluetooth Standby)

You can set the Bluetooth Standby mode so that the receiver can be controlled by a BLUETOOTH device even when the receiver is in standby mode.

1. Select [Setup] - [Bluetooth Settings] from the home menu.
2. Select [Bluetooth Standby].
3. Select [On] or [Off].
 - **On:** You can turn on the receiver from a BLUETOOTH device.
 - **Off**

Note

- If a previously paired device is paired when the receiver is in standby mode, the  (on/standby) indicator on the front panel lights up in amber if [Bluetooth Standby] is set to [On].
 - This function works only when [Bluetooth Mode] is set to [Receiver] or [Transmitter].
 - If you set [Quick Start/Network Standby] to [On] and [Bluetooth Standby] to [On], the receiver turns on when you establish a BLUETOOTH connection from a BLUETOOTH device. (For USA, Canadian and Asia-Pacific models only)
-

Setting BLUETOOTH audio codecs (Bluetooth Codec - AAC/Bluetooth Codec - LDAC)

You can enable and disable AAC (Advanced Audio Coding) or LDAC audio.

1. Select [Setup] - [Bluetooth Settings] from the home menu.
2. Select [Bluetooth Codec - AAC] or [Bluetooth Codec - LDAC].
3. Select [On] or [Off].
 - **On:** AAC and/or LDAC audio is available if the BLUETOOTH device supports AAC or LDAC.
 - **Off:** AAC and/or LDAC audio is not available.

Note

- When you change this setting, the setting is applied from the next time you connect the BLUETOOTH device.
- This function works only when the [Bluetooth Mode] is set to [Receiver] or [Transmitter].

Hint

- You can enjoy high-quality sound if AAC or LDAC is enabled.
- LDAC is an audio coding technology developed by Sony that enables the transmission of High-Resolution (Hi-Res) Audio content, even over a BLUETOOTH connection. Unlike other BLUETOOTH compatible coding technologies such as SBC, it operates without any down-conversion of the Hi-Res Audio content (*), and allows approximately three times more data (**) than those other technologies to be transmitted over a BLUETOOTH wireless network with unprecedented sound quality, by means of efficient coding and optimized packetization.

* excluding DSD format contents

** in comparison with SBC (Subband Coding) when the bitrate of 990kbps (96/48kHz) or 909kbps (88.2/44.1kHz) is selected

Setting the BLUETOOTH sound quality (Wireless Playback Quality)

You can set the transmission data rate for LDAC playback.

1. Select [Setup] - [Bluetooth Settings] from the home menu.
2. Select [Wireless Playback Quality].
3. Select the setting you want.
 - **Auto:** Sets the transmission data rate for LDAC automatically.
 - **Sound Quality:** The highest data rate is used. Sound is sent at a higher quality, but audio playback may become unstable if the link quality is not sufficient.
 - **Standard:** A medium data rate is used. This provides a balance between sound quality and playback stability.
 - **Connection:** Stability is prioritized. The sound quality may be reasonable and the connection status will most likely be stable. This setting is recommended if the connection is unstable.

Note

- This function is only available when [Bluetooth Mode] is set to [Transmitter] and [Bluetooth Codec - LDAC] is set to [On].

[199] Adjusting Settings | Zone Settings (for STR-DN1060 only)

Turning the power for Zone 2/Zone 3/HDMI zone on/off (Power) (for STR-DN1060 only)

You can turn the power for Zone 2/Zone 3/HDMI zone on or off by following the steps below.

1. Select [Setup] - [Zone Settings] from the home menu.
2. Select [Zone2 Power], [Zone3 Power] or [HDMI Zone Power].
3. Select [On] or [Off].

Note

- The amplifiers in the zones other than the main zone remain turned on even when the receiver is in standby mode (press  (on/standby) on the remote control to turn off the receiver).
- When the receiver is in standby mode, the on/standby indicator on the front panel lights

up in amber if the power for Zone 2/Zone 3/HDMI zone is turned on.

Hint

- You can also turn the power for Zone 2/Zone 3/HDMI zone on or off using ZONE POWER on the receiver.

[200] Adjusting Settings | Zone Settings (for STR-DN1060 only)

Selecting source signals for Zone 2/Zone 3/HDMI zone (Input) (for STR-DN1060 only)

You can select the source signals for Zone 2/Zone 3/HDMI zone by following the steps below.

1. Select [Setup] - [Zone Settings] from the home menu.
2. Select [Zone2 Input], [Zone3 Input] or [HDMI Zone Input].
3. Select the source signals you want to output.

Hint

- You can also select the source signals for Zone 2/Zone 3/HDMI zone using ZONE SELECT and INPUT SELECTOR on the receiver while [2. xxxx (input name)], [3. xxxx (input name)] or [H. xxxx (input name)] is shown on the display panel.

[201] Adjusting Settings | Zone Settings (for STR-DN1060 only)

Adjusting the volume for Zone 2/Zone 3 (Volume) (for STR-DN1060 only)

You can adjust the volume for Zone 2 or Zone 3 by following the steps below in the following cases:

- When using the connections described in "[1. Connecting the speakers in Zone 2 and/or Zone 3 \(for STR-DN1060 only\)](#)"
- When using the connections described in "[1. Connecting another amplifier in Zone 2 \(for STR-DN1060 only\)](#)," and when [Zone2 Line Out] is set to [Variable].

1. Select [Setup] - [Zone Settings] from the home menu.
2. Select [Zone2 Volume] or [Zone3 Volume].
3. Select the volume level.

Note

- If [Zone2 Line Out] is set to [Fixed], adjust the volume using the receiver in Zone 2.

Hint

- You can also adjust the volume using ZONE SELECT and MASTER VOLUME on the receiver while [2. xxxx (input name)] or [3. xxxx (input name)] is shown on the display panel.

[202] Adjusting Settings | Zone Settings (for STR-DN1060 only)

Setting the volume control for Zone 2 (Zone2 Line Out) (for STR-DN1060 only)

You can set variable or fixed volume control for the ZONE 2 AUDIO OUT jacks.

1. Select [Setup] - [Zone Settings] from the home menu.
2. Select [Zone2 Line Out].
3. Select the setting you want.
 - **Variable:**
Recommended when using another amplifier that does not have volume control for Zone 2.
The volume for the ZONE 2 AUDIO OUT jacks can be changed.
 - **Fixed:**
Recommended when using another amplifier with variable volume control for Zone 2. The volume for the ZONE 2 AUDIO OUT jacks is fixed.

Note

- When [Variable] is set, the volume is turned down by default. Turn up the volume while listening to the sound after completing setup. The volume for the SPEAKERS SURROUND BACK/BI-AMP/FRONT HIGH/FRONT B/ZONE 2 terminals is changed together with the volume for the ZONE 2 AUDIO OUT jacks.

[203] Adjusting Settings | System Settings

Selecting the language (Language) (for USA, Canadian, European and Australian models only)

You can select the language of messages on the screen.

1. Select [Setup] - [System Settings] from the home menu.
2. Select [Language].
3. Select the language you want.

[204] Adjusting Settings | System Settings

Tuning on/off the display for the volume level or sound field (Auto Display)

This function allows you to turn the information display which appears on the TV screen on or off when the volume level or sound field, etc. of the receiver is changed.

1. Select [Setup] - [System Settings] from the home menu.
2. Select [Auto Display].
3. Select [On] or [Off].

[205] Adjusting Settings | System Settings

Reducing the startup time (Quick Start/Network Standby) (for USA, Canadian and Asia-Pacific models only)

When [On] is selected, the startup time can be shortened and the receiver can be turned on

when it is detected from a device connected to the same network.

1. Select [Setup] - [System Settings] from the home menu.
2. Select [Quick Start/Network Standby].
3. Select the setting you want.
 - On
 - Off

[206] Adjusting Settings | System Settings

Setting standby mode (Auto Standby)

You can set the receiver to switch to standby mode automatically when you do not operate the receiver or when no signals are input to the receiver.

1. Select [Setup] - [System Settings] from the home menu.
2. Select [Auto Standby].
3. Select [On] or [Off].

When you select [On], the receiver switches to standby mode after approximately 20 minutes.

Note

- This function does not work in the following cases:
 - [FM TUNER] is selected as the input.
 - The software of the receiver is being updated.
 - BLUETOOTH headphones are connected.
- If you use the Auto Standby mode and the sleep timer at the same time, the sleep timer has priority.

[207] Adjusting Settings | System Settings

Switching the brightness of the display panel (Dimmer)

Switch the brightness of the display panel between 3 levels.

1. Select [Setup] - [System Settings] from the home menu.
2. Select [Dimmer].
3. Select the setting you want.
 - **100%**
 - **60%**
 - **0%**

Hint

- You can also use the DIMMER button on the receiver.

[208] Adjusting Settings | System Settings

Using the sleep timer (Sleep)

You can set the receiver to turn off automatically at a specified time.

1. Select [Setup] - [System Settings] from the home menu.
2. Select [Sleep].
3. Set specified time.
 - 2:00:00
 - 1:30:00
 - 1:00:00
 - 0:30:00
 - Off

[SLEEP] lights up on the display panel of the receiver when sleep timer is being used.

Hint

- You can check the remaining time before the receiver turns off on the System Settings screen. Also, the remaining time appears on the bottom right of the TV screen when it becomes 1 minute or less.
- The sleep timer will be canceled if you perform the following:
 - Update the software of the receiver.

- Turn the receiver on or off.

[209] Adjusting Settings | System Settings

Receiving information on newer software (Software Update Notification)

You can set whether or not to be informed of newer software version information on the TV screen.

1. Select [Setup] - [System Settings] from the home menu.
2. Select [Software Update Notification].
3. Set to [On] or [Off].

Note

- New software version information does not appear in the following cases:
 - The latest version is already being used.
 - The receiver cannot obtain data via a network.

[210] Adjusting Settings | System Settings

Deleting personal data (Initialize Personal Information)

You can erase personal information stored in the receiver.

If you dispose of, transfer or resell this receiver, please delete all personal information for security purposes. Please take any appropriate measures, such as logging out of any network services you have used.

1. Select [Setup] - [System Settings] from the home menu.
2. Select [Initialize Personal Information].
3. Follow the on-screen instructions.





Note

- Following histories will be erased.
 - Connected BLUETOOTH devices
 - Mobile devices connected using the Screen mirroring function
 - Content input with the on-screen keyboard
-

[211] Adjusting Settings | System Settings

Assigning a name to the receiver (Device Name)

You can assign a device name to the receiver to make it easily recognizable by other devices.

1. Select [Setup] - [System Settings] from the home menu.
2. Select [Device Name].
An on-screen keyboard appears on the TV screen.
3. Press /// and  to select characters one by one to enter the name.
4. Select [Enter].
The name you entered is registered.

[212] Adjusting Settings | System Settings

Checking the software version and MAC address of the receiver (System Information)

You can display the software version information and MAC address of the receiver.

1. Select [Setup] - [System Settings] from the home menu.
 2. Select [System Information].
-

[213] Adjusting Settings | System Settings

Checking software license information (Software License Information)

You can display the software license information.

1. Select [Setup] - [System Settings] from the home menu.
2. Select [Software License Information].
3. Follow the on-screen instructions.

[214] Adjusting Settings | System Settings

Updating the software automatically (Auto Update Settings)

You can set the software to update automatically. If you set [Auto Update] to [On], the auto update is performed from 2:00 AM to 5:00 AM of the selected time zone.

1. Select [Setup] - [System Settings] from the home menu.
2. Select [Auto Update Settings].
3. Select [Auto Update] and set to [On].
4. Confirm [Time Zone] is selected and then press .
5. Select the area and then select the nearest city to where you live.

Note

- To use the auto update function, set [Auto Update] to [On].
- To update the software at the midnight while the receiver is not used, set [Auto Update] to [On] and also set [Quick Start/Network Standby] to [On].
- If [Auto Update] is set to [On] while [Quick Start/Network Standby] is set to [Off], update starts automatically while the receiver is turned off.
- Depending on the provided update type, the update may start automatically even if [Auto Update] is set to [Off], or the update may start automatically while the receiver is turned off.

Updating the software (Software Update)



1. Select [Setup] - [System Settings] from the home menu.
2. Select [Software Update].
3. Select [Update via Internet] or [Update via USB Memory].
If you select [Update via USB Memory], please visit the customer support website to download the latest software version.
4. Update the software.
[UPDATING] flashes on the display panel during the software update process.
However, [UPDATING] may disappear temporarily during updating.
5. Restart the receiver.
When the update is completed, [COMPLETE] appears on the display panel and the receiver restarts automatically.

Note

- It may take about 1 hour for the update to be completed.
- Do not turn the receiver off while the software is being updated. It may cause a malfunction.
- You cannot restore the old version after updating the software.

Operating the receiver with the menu on the display panel

You can operate this receiver using the display panel even if the TV is not connected to the receiver.

1. Press AMP MENU.
The menu is displayed on the display panel of the receiver.
2. Press / repeatedly to select the menu you want, then press .

3. Press \uparrow/\downarrow repeatedly to select the parameter you want to adjust, then press \rightarrow .

4. Press \uparrow/\downarrow repeatedly to select the setting you want, then press \rightarrow .

To return to the previous display

Press \leftarrow or BACK.

To exit the menu

Press AMP MENU.

Note

- Some parameters and settings may appear dimmed on the display panel. This means that they are either unavailable or fixed and unchangeable.

[217] Adjusting Settings | Using the menu on the display panel

Viewing information on the display panel

The display panel provides various information on the status of the receiver, such as the sound field.

1. Select the input for which you want to check information.
2. Press DISPLAY MODE on the receiver repeatedly.

Each time you press DISPLAY MODE, the display will change cyclically as follows:

Index name of the input (*1) - Input you selected - Sound field currently applied (*2) -
Volume level - Stream information (*3)

When listening to FM radio

Preset station name (*1) - Frequency - Sound field currently applied (*2) - Volume level

When receiving RDS broadcasts (for European and Asia-Pacific models only)

Program service name or preset station name (*1) - Frequency, band and preset number - Sound field currently applied (*2) - Volume level

*1 Index name appears only when you have assigned one to the input or preset station. Index name does not appear if only blank spaces have been entered or it is same as the input name.

*2 [PURE.DIRECT] appears on the display panel when the Pure Direct function is activated.

*3 Stream information may not be displayed.

Note

- Characters or marks in some languages may not be displayed.

[218] Adjusting Settings | Reverting to the factory default settings

Reverting to the factory default settings

You can clear all memorized settings and restore the receiver to the factory default settings by the following procedure. This procedure can also be used to initialize the receiver before you use it for the first time.

Be sure to use the buttons on the receiver to perform this operation.

1. Turn off the receiver.
2. Hold down I/O (on/standby) on the receiver for 5 seconds.
[CLEARING] flashes on the display panel for a while, then changes to [CLEARED !].

Note

- It takes a few minutes for the memory to be cleared completely. Do not turn the receiver off until [CLEARED !] appears on the display panel.

[219] Troubleshooting | Error messages

PROTECTOR

The receiver will automatically turn off after a few seconds. Check the followings:

- There may be an electrical surge or power failure. Unplug the AC power cord (mains lead) and then plug in the cord again after 30 minutes.
- The receiver is covered and the ventilation holes are blocked. Remove the object covering the ventilation holes of the receiver.
- The impedance of the connected speakers is below the rated impedance range indicated on the back panel of the receiver. Reduce the volume level.
- Unplug the AC power cord (mains lead) and let the receiver cool down for 30 minutes while performing the following troubleshooting:
 - Disconnect all of the speakers and subwoofer.
 - Check that the speaker wires are tightly twisted on both ends.
 - Connect the front speaker first, increase the volume level and operate the receiver for at least 30 minutes until it completely warms up. Then, connect each additional speaker one by one and test each additional speaker until you detect which speaker is causing the protection error.

After checking the above items and fixing any problems, plug in the AC power cord (mains lead) and turn on the receiver. If the problem persists, consult your nearest Sony dealer.

[220] Troubleshooting | Error messages

An over-current from the USB port was detected.

Disconnect all USB devices as prompted in the warning message and close the message.

[221] Troubleshooting | Error messages

List of messages after Auto Calibration measurements

- **Code 30:**
Headphones are connected to the PHONES jack on the receiver. Remove the headphones and perform the Auto Calibration again.
- **Code 31:**
Front speakers are not selected properly. Select the front speakers using SPEAKERS and perform the Auto Calibration again. For details on selecting the front speakers, see [“4. Selecting the front speakers.”](#)
- **Code 32, Code 33:**
Speakers were not detected or not connected properly.
 - None of the front speakers are connected or only one front speaker is connected.
 - Either the surround left or surround right speaker is not connected.
 - Surround back speakers or front high speakers are connected even though surround speakers are not connected. Connect the surround speaker(s) to the SPEAKERS SURROUND terminals.
 - A surround back speaker is connected only to the SPEAKERS SURROUND BACK/BI-AMP/FRONT HIGH/FRONT B R terminal. If connecting only one surround back speaker, connect it to the SPEAKERS SURROUND BACK/BI-AMP/FRONT HIGH/FRONT B L terminal.
 - Either the front high left or front high right speaker is not connected.

The optimizer microphone is not connected. Make sure that the optimizer microphone is connected properly and perform the Auto Calibration again.

If the optimizer microphone is connected properly but the error code still appears, the optimizer microphone cable may be damaged.
- **Warning 40:**
The measurement process has been completed and a high noise level has been detected. You may be able to achieve better results if you try the process again in a quiet environment.

- **Warning 41, Warning 42:**

The input from the microphone is too large.

- The distance between the speaker and the microphone may be too small. Set them further apart and perform the measurement again.

- **Warning 43:**

The distance and position of a subwoofer cannot be detected. This may be caused by noise. Try performing the measurement in a quiet environment.

[222] Troubleshooting | General

The receiver is turned off automatically.

- [Auto Standby] is set to [On].
 - The sleep timer function was activated.
 - [PROTECTOR] was activated.
-

[223] Troubleshooting | General

Cannot find an available input when connecting several digital devices.

You can reassign the COMPONENT VIDEO and COAXIAL/OPTICAL digital audio input jacks to other inputs.

See “[Using other video/audio input jacks \(Input Assign\).](#)”

[224] Troubleshooting | Image

No image appears on the TV.

- Select the appropriate input using the input buttons.
- Set your TV to the appropriate input mode.
- Move your audio device away from the TV.
- Assign the component video input correctly (for STR-DN1060 only).
- Make sure that cables are correctly and securely connected to devices.
- Some playback devices need to be set up. Refer to the operating instructions supplied

with each device.

- Be sure to use a High Speed HDMI cable when you view images or listen to sound, especially for 1080p, Deep Color (Deep Colour), 4K or 3D transmission.
- The output of the HDMI video signals of the receiver may be set to [HDMI OFF]. In this case,
 - set to [HDMI ON] (for STR-DN860 only).
 - set to [HDMI A], [HDMI B], or [HDMI A + B] (for STR-DN1060 only).
- If you want to play HDCP 2.2 content, be sure to connect the device to the HDCP 2.2-compatible HDMI input and output of the receiver. Also check that the TV is compatible with HDCP 2.2.

[225] Troubleshooting | Image

No 3D image appears on the TV.

- Depending on the TV or the video device, 3D images may not be displayed. Check the HDMI video formats supported by the receiver.
- Be sure to use a High Speed HDMI cable.

[226] Troubleshooting | Image

No 4K image appears on the TV.

- Depending on the TV or the video device, 4K images may not be displayed. Check the video capability and settings of your TV and video device. Also, make sure you connect the video device to the 4K-compatible HDMI IN jack of this receiver.
- Be sure to use a High Speed HDMI cable.
- If you want to playback HDCP 2.2 content, be sure to connect the device and TV to the HDCP 2.2 capable HDMI input and output of the receiver. Also check that the TV is compatible with HDCP 2.2.

[227] Troubleshooting | Image

No image is output from the TV when the receiver is in standby mode.

- When the receiver enters standby mode, the image from the last HDMI device selected before you turned off the receiver is displayed. If you are enjoying content from another device, play the content on the device and perform the One-Touch Play operation, or turn on the receiver to select the HDMI device from which you want to enjoy content.
 - Make sure [Standby Through] is set to [On] or [Auto] in the HDMI Settings menu.
-

[228] Troubleshooting | Image

The home menu does not appear on the TV screen.

- The home menu can only be used when you connect the TV to the HDMI OUT A (TV) (*) or HDMI TV OUT (**) jack.
- Press HOME to display the home menu.
- Check that the TV is connected correctly.
- The home menu may take some time to appear on the TV screen depending on the TV.

* For STR-DN1060 only

** For STR-DN860 only

[229] Troubleshooting | Image

The display panel is turned off.

- If the PURE DIRECT indicator on the front panel lights up, press PURE DIRECT to turn off this function.
 - Press DIMMER on the receiver to adjust the brightness of the display panel.
-

[230] Troubleshooting | Sound

No sound or only a very low level of sound is heard, no matter which device is selected.

- Check that all connecting cables are inserted to their input/output jacks on the receiver, speakers and the devices.
- Check that the receiver and all devices are turned on.

- Check that MASTER VOLUME on the receiver is not set to [VOL MIN].
 - Check that SPEAKERS on the receiver is not set to [SPK OFF].
 - Check that headphones are not connected to the receiver.
 - Press  to cancel the muting function.
 - Try pressing the input button on the remote control or turning INPUT SELECTOR on the receiver to select the device of your choice.
 - If you want to listen to sound from the TV speaker, set [Audio Out] to [TV + AMP] in the HDMI Settings menu. If you cannot play multi-channel audio source, set [AMP]. However, the sound will not be output through the TV speaker.
 - Sound may be interrupted when the sampling frequency, number of channels or audio format of audio output signals from the playback device is switched.
 - If you are listening with BLUETOOTH headphones, check that the [Bluetooth Mode] is not set to [Receiver] or [Off].
-

[231] Troubleshooting | Sound

There is severe humming or noise.

- Check that the speakers and device are connected securely.
 - Check that the connecting cables are not near a transformer or motor, and are at least 3 meters (10 feet) away from a TV set or fluorescent light.
 - Move your audio device away from the TV.
 - The plugs and jacks are dirty. Wipe them with a cloth slightly moistened with alcohol.
-

[232] Troubleshooting | Sound

No sound or only a very low level of sound is heard from specific speakers.

- Connect a pair of headphones to the PHONES jack to verify that sound is output from the headphones. If only one channel is output from the headphones, the device may not be connected to the receiver correctly. Check that all of the cables are fully inserted into the jacks on both the receiver and the device.
If both channels are output from the headphones, the front speaker may not be connected to the receiver correctly. Check the connection of the front speaker that is not outputting any sound.
- Make sure you have connected to both the L and R jacks of an analog device, as analog

devices require both L and R jack connections. Use an audio cable (not supplied).

- Adjust the speaker level.
- Check that the speaker settings are appropriate for the setup using [Auto Calibration] or [Speaker Pattern] in the Speaker Settings menu. Then check that sound is output from each speaker correctly using [Test Tone] in the Speaker Settings menu.
- Some discs have no Dolby Digital Surround EX information. In this case, sound may not be output from some speakers.
- Check that the subwoofer is connected correctly and securely.
- Make sure you have turned on your subwoofer.
- Depending on the selected sound field, sound may not be available from the subwoofer.
- Depending on the source, there may be no sound from the subwoofer when all speakers are set to [Large] and [Neo:6 Cinema] or [Neo:6 Music] is selected.

[233] Troubleshooting | Sound

There is no sound from a specific device.

- Check that the device is correctly connected to the corresponding audio input jacks.
- Check that the cable(s) used for the connection is (are) fully inserted into the jacks on both the receiver and the device.
- Check the Input Mode setting.
- Check that the device is correctly connected to the corresponding HDMI jack.
- The HDMI settings of some playback devices need to be configured. Refer to the operating instructions supplied with each device.
- Be sure to use a High Speed HDMI cable when you view images or listen to sound, especially for 1080p, Deep Color (Deep Colour), 4K or 3D transmission.
- Sound may not be output from the receiver while the home menu is displayed on the TV screen. Press HOME to exit the home menu.
- Audio signals (format, sampling frequency, bit length, etc.) transmitted from an HDMI jack may be suppressed by the connected device. Check the setup of a device connected via an HDMI cable if the image is poor or the sound does not come out of the device.
- When a connected device does not support the copyright protection technology (HDCP), the image and/or the sound from the HDMI OUT jack may be distorted or may not be output. If this is the case, check the specifications of the connected device.
- Set the image resolution of the playback device to more than 720p/1080i to enjoy High Bitrate Audio (DTS-HD Master Audio, Dolby TrueHD).
- The image resolution of the playback device may need to be configured to certain settings before you can enjoy DSD and Multi Channel Linear PCM. Refer to the operating instructions of the playback device.
- Make sure the TV supports the System Audio Control function.
- If the TV does not have a System Audio Control function, set [Audio Out] in the HDMI

Settings menu to:

- [TV + AMP] if you want to listen to the sound from the TV speaker and receiver.
- [AMP] if you want to listen to the sound from the receiver only.
- When you connect the receiver to a video device (projector, etc.), sound may not be output from the receiver. In this case, set [Audio Out] to [AMP] in the HDMI Settings menu.
- You cannot listen to the sound of a device connected to the receiver while TV input is selected on the receiver.
 - Be sure to change the input of the receiver to HDMI if you want to watch a program on a device connected via HDMI connection to the receiver.
 - Change the TV channel if you want to watch a TV broadcast.
 - Be sure to select the correct device or input when watching a program from a device connected to the TV. Refer to the section on this operation in the operating instructions of the TV.
- Sound is not output if you use [Analog Direct] when an HDMI input or digital input (COAXIAL or OPTICAL) is selected. Use another sound field.
- When using the Control for HDMI function, you cannot control connected devices using the remote control of the TV.
 - Some devices and TVs need to be set up. Refer to the operating instructions supplied with each device and TV.
 - Change the input of the receiver to the HDMI input connected to the device.
- Check that the selected digital audio input jack is not assigned to another input.

[234] Troubleshooting | Sound

There is no sound from the TV via the HDMI OUT (ARC) jack when using the Audio Return Channel function.

- Set [Control for HDMI] to [On] in the HDMI Settings menu.
- Make sure that your TV is compatible with the Audio Return Channel function.
- Make sure that the HDMI cable is connected to a jack on your TV that is compatible with the Audio Return Channel function.

[235] Troubleshooting | Sound

The left and right sound is unbalanced or reversed.

- Check that the speakers and device are connected correctly and securely.
- Adjust the sound level parameters using the Speaker Settings menu.

[236] Troubleshooting | Sound

Dolby Digital or DTS multi-channel sound is not reproduced.

- Check that the DVD, etc. you are playing is recorded in Dolby Digital or DTS format.
- When connecting the DVD player, etc., to the digital input jacks of this receiver, make sure the digital audio output setting of the connected device is available.
- Set [Audio Out] to [AMP] in the HDMI Settings menu.
- You can only enjoy High Bitrate Audio (DTS-HD Master Audio, Dolby TrueHD), DSD and Multi Channel Linear PCM with an HDMI connection.

[237] Troubleshooting | Sound

The surround effect cannot be obtained.

- Make sure you have selected a sound field for movies or music.
- [PLII Movie], [PLII Music], [PLIIX Movie], [PLIIX Music], [Neo:6 Cinema] and [Neo:6 Music] do not work when the speaker pattern is set to 2/0 or 2/0.1.

[238] Troubleshooting | Sound

A test tone is not output from the speakers.

- The speaker cables may not be connected securely. Check that they are connected securely and cannot be disconnected by pulling on them slightly.
- The speaker cables may have short-circuited.

[239] Troubleshooting | Sound

A test tone is output from a different speaker than the speaker displayed on the TV screen.

-
- The speaker pattern setup is incorrect. Make sure that the speaker connections and the speaker pattern match correctly.
-

[240] Troubleshooting | Sound

No sound is output from the TV when the receiver is in standby mode.

- When the receiver enters standby mode, sound is output from the last HDMI device selected before you turned off the receiver. If you are enjoying content from another device, play the content on the device and perform the One-Touch Play operation, or turn on the receiver to select the HDMI device from which you want to enjoy content.
 - Make sure [Standby Through] is set to [On] or [Auto] in the HDMI Settings menu.
-

[241] Troubleshooting | Tuner

The FM reception is poor.

- Extend and adjust the position of the FM wire antenna (aerial) to a place where the reception conditions are good.
 - Place the FM wire antenna (aerial) near a window.
-

[242] Troubleshooting | Tuner

The FM stereo reception is poor.

Perform the following procedure:

1. Select [Listen] - [FM TUNER] from the home menu.
2. Select a station on the FM band.
3. Press OPTIONS.

4. Select [FM Mode] from the menu.

5. Select [Monaural].

Note

- You can set FM mode in the options menu if the frequency indication is selected in step 3.

[243] Troubleshooting | Tuner

You cannot tune to radio stations.

- Check that the antennas (aerials) are connected securely. Adjust the antennas (aerials) if necessary.
- The signal of the stations is too weak with automatic tuning. Use direct tuning.
- No stations have been preset or the preset stations have been cleared (when tuning by scanning preset stations is used). Preset the stations.
- Press DISPLAY MODE on the receiver repeatedly so that the frequency appears on the display panel.

[244] Troubleshooting | Tuner

RDS does not work (for European and Asia-Pacific models only).

- Make sure that you are tuned to an FM RDS station.
- Select a stronger FM station.
- The station you tuned to is not transmitting the RDS signal or the signal is weak.

[245] Troubleshooting | Tuner

The RDS information that you want does not appear (for European and Asia-Pacific models only).

- The service may be temporarily out of order. Contact the radio station and find out whether they actually provide the service in question.
-

[246] Troubleshooting | iPhone/iPad/iPod

The sound is distorted.

- Press  - on the remote control repeatedly. You can also use MASTER VOLUME on the receiver.
-

[247] Troubleshooting | iPhone/iPad/iPod

There is no sound from an iPhone/iPod.

- Disconnect the iPhone/iPod and connect it again.
-

[248] Troubleshooting | iPhone/iPad/iPod

An iPhone/iPad/iPod cannot be charged.

- Check that the receiver is turned on.
 - Make sure the iPhone/iPod is connected securely.
 - The receiver cannot charge iPad devices.
-

[249] Troubleshooting | iPhone/iPad/iPod

An iPhone/iPad/iPod cannot be operated.

- Depending on the content of the iPhone/iPad/iPod, it may take time to start playback.
- Turn off the receiver, then disconnect the iPhone/iPad/iPod. Turn on the receiver again and reconnect the iPhone/iPad/iPod.
- You are using an incompatible iPhone/iPad/iPod.

[250] Troubleshooting | iPhone/iPad/iPod

The ringtone volume of an iPhone does not change.

- Adjust the ring volume using the controls on the iPhone.

[251] Troubleshooting | USB devices

Are you using a compatible USB device?

- If you connect an incompatible USB device, the following problems may occur.
 - The USB device is not recognized.
 - File or folder names are not displayed on this receiver.
 - Playback is not possible.
 - The sound skips.
 - There is noise.
 - Distorted sound is output.

[252] Troubleshooting | USB devices

There is noise, skipping, or distorted sound.

- Turn off the receiver, reconnect the USB device, and then turn on the receiver.
- The music data itself contains noise, or the sound is distorted.

[253] Troubleshooting | USB devices

A USB device is not recognized.

- Turn off the receiver, then disconnect the USB device. Turn on the receiver again and reconnect the USB device.
- Connect a compatible USB device.
- The USB device does not work properly. Refer to the section on how to deal with this

problem in the operating instructions of the USB device.

[254] Troubleshooting | USB devices

Playback does not start.

- Turn off the receiver, reconnect the USB device, and then turn on the receiver.
 - Connect a compatible USB device.
 - Select [USB] and select a folder/track, then press ►|| to start playback.
-

[255] Troubleshooting | USB devices

A USB device cannot be connected to the USB port.

- The USB device is being connected upside down. Connect the USB device in the correct orientation.
-

[256] Troubleshooting | USB devices

Erroneous display.

- The data stored in the USB device may have been corrupted.
- The character codes that can be displayed by this receiver are as follows:
 - Upper case letters (A to Z)
 - Lower case letters (a to z)
 - Numbers (0 to 9)
 - Symbols (' = < > * + , - . / @ [\] _ `)

Other characters may not be displayed correctly.

[257] Troubleshooting | USB devices

An audio file cannot be played.

- MP3 files in MP3 PRO format cannot be played.
 - The audio file is a multiple track audio file.
 - Some AAC files may not be played correctly.
 - If you use a partitioned USB device, only audio files on the first partition can be played.
 - Playback is possible up to nine levels (including the [ROOT] folder).
 - There are more than 500 folders (including the [ROOT] folder).
 - There are more than 500 files.
 - Files that are encrypted, protected by passwords, etc. cannot be played.
-

[258] Troubleshooting | Network connection

Cannot connect to the network using WPS via a wireless LAN connection.

- You cannot connect to a network using WPS if your access point is set to WEP. Set up your network after searching the access point using the access point scan.
-

[259] Troubleshooting | Network connection

Cannot connect to the network.

- Check that the LAN cable is connected to the receiver when you want to connect the receiver to the network via a wired LAN connection.
 - Check the network information. If the connection failed, set up the network connection again.
 - If the receiver is connected through a wireless network, move the receiver and the wireless LAN router/access point closer to each other and perform the setup again.
 - Make sure that you use a wireless LAN router/access point.
 - Make sure that the wireless LAN router/access point is turned on.
 - Check the settings of the wireless LAN router/access point and perform the setup again. For details on the settings of devices, refer to the operating instructions of the devices.
 - Wireless networks are influenced by electromagnetic radiation emitted by microwave ovens and other devices. Move the receiver away from these devices.
-

[260] Troubleshooting | Network connection

Cannot control the receiver using a “SongPal” device.

- It may take some time for the receiver to connect to the network after it is turned on. Try again later.
 - The smartphone or tablet device may not be connected to the same network as the receiver. Connect to the same network and try again.
 - Also see “[Controller devices or applications on the home network cannot connect to the receiver.](#)”
 - Also refer to the “SongPal” help.
-

[261] Troubleshooting | Network connection

Cannot control the receiver using a TV SideView device.

- It may take some time for the receiver to connect to the network after it is turned on. Try again later.
 - The smartphone or tablet device may not be connected to the same network as the receiver. Connect to the same network and try again.
 - The receiver may have been removed from the TV SideView device list. Remove the TV SideView device from the receiver as well, and then register again.
 - The TV SideView device may have been removed from the receiver device list. Remove the receiver from the TV SideView device list as well, and then register again.
 - Also see “[Controller devices or applications on the home network cannot connect to the receiver.](#)”
 - Also refer to the TV SideView help.
-

[262] Troubleshooting | Network connection

Cannot select the Network Settings menu.

- Wait for a few moments after you have turned on the receiver, and then select the Network Settings menu again.
-

[263] Troubleshooting | Home Network

Cannot connect to the network.

- Make sure the router or the wireless LAN router/access point is turned on.
 - The network settings on the receiver may be incorrect.
If the connection failed, set up the network connection again.
 - Confirm that the receiver is connected to the router or the wireless LAN router/access point correctly.
 - If the receiver is connected to a wireless network, move the receiver and the wireless LAN router/access point closer to each other.
 - If you have initialized the receiver or performed a system recovery on your server, perform the network settings again.
-

[264] Troubleshooting | Home Network

A server does not appear in the server list. ([Cannot find the server.] appears on the TV screen.)

- You may have turned on this receiver before you turned on the server. Refresh the server list.
 - Make sure that the router or the wireless LAN router/access point is turned on.
 - The server may require some settings to accept the connection from the receiver.
Confirm that the server has been configured correctly. Confirm that the receiver is allowed to receive music streamed from the server.
 - Confirm that the receiver and the server are connected to the router or the wireless LAN router/access point correctly. Check the network settings information.
 - Refer to the operating instructions of your router or wireless LAN router/access point and check the multicast setting. Try turning the multicast setting on or off on the wireless LAN router/access point.
 - If your server is a software application on your PC, check the firewall setup and the security software settings.
-

[265] Troubleshooting | Home Network

Playback does not start, or the player does not automatically proceed to the next track or file.

- Make sure that the audio file you are trying to play is in a format supported by this receiver.
 - Audio content with DRM (Digital Rights Management) copyright protection cannot be played on this receiver.
 - Make sure that the repeat setting and shuffle setting are configured correctly. Press OPTION, then select [Repeat Setting] or [Shuffle Setting] from the options menu to set to the playback mode.
-

[266] Troubleshooting | Home Network

The sound skips during playback.

- The bandwidth of your network may be too low. Check your router and the network environment.
 - The bandwidth of your network may be too low. If using wireless LAN connection, move the receiver and the wireless LAN router/access point closer to each other, without any obstructions between them.
 - The server may be busy. If using your computer as a server, the computer may be running too many applications. If anti-virus software is active on the computer, temporarily disable it as anti-virus software needs a large amount of system resources.
 - Depending on the network environment, it may not be possible to play tracks with more than one device operating at the same time. Turn off other devices to enable the receiver to play tracks.
-

[267] Troubleshooting | Home Network

[No playable file in this category.] appears.

- If there are no folders or files that can be played on the receiver in the selected folder, you cannot expand the folder to display its contents.
-

[268] Troubleshooting | Home Network

Cannot play copyrighted files.

Audio content with DRM (Digital Rights Management) copyright protection cannot be played on this receiver.

[269] Troubleshooting | Home Network

Cannot select a previously selected track.

- The track information may have been changed on the server. Refresh the server list and then reselect the server.
-

[270] Troubleshooting | Home Network

Controller devices or applications on the home network cannot connect to the receiver.

- Confirm that the network is correctly set up.
 - The device is set to [Block] in [Renderer Access Control], or not added to the list.
 - A maximum of 20 connectable devices has been set. Delete unnecessary devices on the device list and then set [Auto Renderer Access Permission] to [On].
 - Server operation of the receiver is suspended if the receiver is conducting one of the following operations:
 - Playing a track stored on the server (the receiver is operating as a player)
 - Updating the software
 - Formatting the system
 - Changing the settings
 - Screen mirroring
 - [External Control] is set to [Off]. Set it to [On] to control the receiver with a home automation controller.
 - When using TV SideView, also see “[Cannot control the receiver using a TV SideView device.](#)”
 - When using “SongPal”, also see “[Cannot control the receiver using a “SongPal” device.](#)”
-

[271] Troubleshooting | Home Network

The receiver cannot be turned on by devices on a

network.

- The receiver itself does not support the Wake-on-LAN.
 - Set [Remote Start] to [On] if you want to turn the receiver on by operating the devices on a network.
-

[272] Troubleshooting | AirPlay

The receiver cannot be found from an iPhone/iPad/iPod or iTunes.

- Make sure the iPhone/iPad/iPod or computer with iTunes is connected to your home network.
 - Update the software of the receiver and the iPhone/iPad/iPod or iTunes to the latest version.
-

[273] Troubleshooting | AirPlay

The sound skips.

- The sound may skip depending on factors such as the network environment. Depending on the audio files, playback may require network speed. If you use a wired LAN connection, check the network hub and/or router. If you use a wireless LAN connection, check the access point and/or router.
-

[274] Troubleshooting | AirPlay

The receiver cannot be operated.

- Update the software of the iPhone/iPad/iPod or iTunes to the latest version.
- Update the software of the receiver to the latest version.
- Connection between the AirPlay device and receiver may be lost. Restart the AirPlay device and/or the receiver.

[275] Troubleshooting | Music Services

Cannot connect the receiver to a service.

- Make sure that the router or the wireless LAN router/access point is turned on.
- Check [Network Connection Status]. If [Not accessible] or [Failed] appears, set up the network connection again.
- If the receiver is connected to a wireless network, move the receiver and the wireless LAN router/access point closer to each other.
- If your contract with your Internet provider limits Internet connection to one device at a time, this device will not be able to access the Internet when another device is already connected. Consult your carrier or service provider.

[276] Troubleshooting | Music Services

The sound skips.

- The bandwidth of your network may be too low. If using wireless LAN connection, move the receiver and the wireless LAN router/access point closer to each other, without any obstructions between them.

[277] Troubleshooting | BLUETOOTH device

Pairing cannot be done.

- Move the BLUETOOTH device closer to the receiver.
- Pairing may not be possible if there are other BLUETOOTH devices near the receiver. In this case, turn off the other BLUETOOTH devices.
- Correctly enter the same passkey that was entered on the BLUETOOTH device.

[278] Troubleshooting | BLUETOOTH device

Cannot make a BLUETOOTH connection.

-
- Confirm that the BLUETOOTH mode is selected correctly.
 - The BLUETOOTH device you attempted to connect does not support the A2DP profile, and cannot be connected with the receiver.
 - Press BLUETOOTH on the receiver to connect to the last connected BLUETOOTH device.
 - Turn on the BLUETOOTH function of the BLUETOOTH device.
 - Establish a connection from the BLUETOOTH device.
 - The pairing registration information has been erased. Perform the pairing operation again.
 - While connected to a BLUETOOTH device, this receiver cannot be detected.
 - Erase the pairing registration information of the BLUETOOTH device and perform the pairing operation again.

[279] Troubleshooting | BLUETOOTH device

The sound skips or fluctuates, or the connection is lost.

- The receiver and the BLUETOOTH device are too far apart.
- If there are obstructions between the receiver and your BLUETOOTH device, remove these or move the receiver and/or device avoid them.
- If there is a device that generates electromagnetic radiation, such as a wireless LAN, other BLUETOOTH device, or a microwave oven nearby, move it away.

[280] Troubleshooting | BLUETOOTH device

The sound of your BLUETOOTH device cannot be heard on the receiver.

- Turn up the volume on your BLUETOOTH device first, and then adjust the volume using  + (or MASTER VOLUME on the receiver).

[281] Troubleshooting | BLUETOOTH device

Severe humming or noise.

- If there are obstructions between the receiver and your BLUETOOTH device, remove them or move the receiver and/or device avoid them.
 - If there is a device that generates electromagnetic radiation, such as a wireless LAN, other BLUETOOTH device, or a microwave oven nearby, move it away.
 - Turn down the volume of the connected BLUETOOTH device.
-

[282] Troubleshooting | BLUETOOTH device

Cannot control the receiver using a “SongPal” device.

- It may take some time for the receiver to connect to the network after it is turned on. Try again later.
 - The smartphone or tablet device may not be connected to the same network as the receiver. Connect to the same network and try again.
 - Also see [“Controller devices or applications on the home network cannot connect to the receiver.”](#)
 - Also refer to the “SongPal” help.
-

[283] Troubleshooting | “BRAVIA” Sync (Control for HDMI)

The Control for HDMI function does not work.

- Check the HDMI connection.
- Make sure [Control for HDMI] is set to [On] in the HDMI Settings menu.
- Make sure the connected device supports the Control for HDMI function.
- Check the Control for HDMI settings on the connected device. Refer to the operating instructions of the connected device.
- If you unplug the HDMI cable or change the connection, repeat the procedures of [“Preparing for “BRAVIA” Sync.”](#)
- When [Control for HDMI] is set to [Off], “BRAVIA” Sync does not work properly, even if the device is connected to the HDMI IN jack.
- The types and number of devices that can be controlled by the “BRAVIA” Sync feature are restricted by the HDMI CEC standard as follows:
 - Recording devices (Blu-ray Disc recorders, DVD recorders, etc.): up to 3 devices
 - Playback devices (Blu-ray Disc players, DVD players, etc.): up to 3 devices
 - Tuner-related devices: up to 4 devices (the receiver uses one of them for its GUI operations.)
 - AV receivers (audio systems): up to 1 device
- Make sure your TV is connected to the HDMI OUT A (TV) jack of the receiver (for STR-

DN1060 only).

- Make sure the HDMI OUTPUT setting is set to [HDMI A] or [HDMI A + B] (for STR-DN1060 only).

[284] Troubleshooting | “BRAVIA” Sync (Control for HDMI)

TV sound cannot be heard from the speakers connected to the receiver.

-
- Make sure [Control for HDMI] is set to [On] in the HDMI Settings menu.
 - Make sure [Input Mode] for the TV input is set to [Auto].
 - Make sure your TV supports the ARC function. Make sure that the HDMI input of your TV is labeled “ARC.”
 - If your TV has multiple HDMI input jacks, make sure the receiver is connected to the one supports the ARC function.
 - Make sure your TV is connected to the HDMI OUT A (TV) jack of the receiver. (for STR-DN1060 only)
 - Make sure the HDMI OUTPUT setting is set to [HDMI A] or [HDMI A + B]. (for STR-DN1060 only)

[285] Troubleshooting | “BRAVIA” Sync (Control for HDMI)

An MHL-compatible source device cannot be charged.

-
- Check that the receiver is turned on.
 - Make sure the device is connected securely.

[286] Troubleshooting | “BRAVIA” Sync (Control for HDMI)

No image from an MHL-compatible source device.

-
- Check the settings of your device. For details, refer to the operating instructions of your device.
 - Check that the device is connected via an MHL cable to the HDMI/MHL (VIDEO 2 IN) (*) or HDMI IN SAT/CATV (MHL) jacks.

- Be sure to use an authorized MHL cable that bears the MHL logo.

* For STR-DN1060 only

[287] Troubleshooting | Remote control

The remote control does not function.

- Point the remote control at the remote control sensor on the receiver.
- Remove any obstructions between the remote control and the receiver.
- Replace both of the batteries in the remote control with new ones if they are weak.

[288] Troubleshooting | If the problem is not solved

Reverting to the factory default settings

You can clear all memorized settings and restore the receiver to the factory default settings by the following procedure. This procedure can also be used to initialize the receiver before you use it for the first time.

Be sure to use the buttons on the receiver to perform this operation.

1. Turn off the receiver.
2. Hold down I/ON (on/standby) on the receiver for 5 seconds.
[CLEARING] flashes on the display panel for a while, then changes to [CLEARED !].

Note

- It takes a few minutes for the memory to be cleared completely. Do not turn the receiver off until [CLEARED !] appears on the display panel.

[289] Troubleshooting | If the problem is not solved

Resetting sound fields to the default settings

Be sure to use the buttons on the receiver to perform this operation.

1. Turn off the receiver.
2. Hold down MUSIC and press I/D (on/standby) on the receiver.
[S.F. CLEAR] appears on the display panel and all sound fields are reset to their default setting.

[290] Troubleshooting | If the problem is not solved

Customer support websites

Refer to the following websites for the latest information on the receiver.

For customers in the USA:

<http://esupport.sony.com/>

For customers in Canada:

<http://esupport.sony.com/CA/>

For customers in Latin America:

<http://esupport.sony.com/LA>

For customers in Europe:

www.sony.eu/support

For customers in Asia-Pacific countries and regions:

<http://www.sony-asia.com/support>

[291] Other Information | Trademarks

Trademarks

- This receiver incorporates Dolby (*) Digital and Pro Logic Surround and the DTS (**) Digital Surround System.

* Manufactured under license from Dolby Laboratories. Dolby, Pro Logic, Surround EX, and the double-D symbol are trademarks of Dolby Laboratories.

** For DTS patents, see <http://patents.dts.com>. Manufactured under license from DTS Licensing Limited. DTS, DTS-HD, the Symbol, & DTS and the Symbol together are registered trademarks, and DTS-HD Master Audio is a trademark of DTS, Inc. © DTS, Inc. All Rights Reserved.

- This receiver incorporates High-Definition Multimedia Interface (HDMI™) technology. The terms HDMI and HDMI High-Definition Multimedia Interface, and the HDMI Logo are trademarks or registered trademarks of HDMI Licensing LLC in the United States and

other countries.

- Apple, the Apple logo, AirPlay, iPad, iPhone, iPod, iPod classic, iPod nano, iPod touch, and Retina are trademarks of Apple Inc., registered in the U.S. and other countries. iPad Air and iPad mini are trademarks of Apple Inc.

App Store is a service mark of Apple Inc.

- “Made for iPod,” “Made for iPhone,” and “Made for iPad” mean that an electronic accessory has been designed to connect specifically to iPod, iPhone, or iPad, respectively, and has been certified by the developer to meet Apple performance standards.

Apple is not responsible for the operation of this device or its compliance with safety and regulatory standards. Please note that the use of this accessory with iPod, iPhone or iPad may affect wireless performance.

- Windows Media is either a registered trademark or trademark of Microsoft Corporation in the United States and/or other countries.
- This product is protected by certain intellectual property rights of Microsoft Corporation. Use or distribution of such technology outside of this product is prohibited without a license from Microsoft or an authorized Microsoft subsidiary.
- LDAC™ and LDAC logo are trademarks of Sony Corporation.
- “DSEE HX” is a trademark of Sony Corporation.
- MPEG Layer-3 audio coding technology and patents licensed from Fraunhofer IIS and Thomson.
- “x.v.Color (x.v.Colour)” and “x.v.Color (x.v.Colour)” logo are trademarks of Sony Corporation.
- “BRAVIA” is a trademark of Sony Corporation.
- “PlayStation” is a registered trademark of Sony Computer Entertainment Inc.
- “WALKMAN” and “WALKMAN” logo are registered trademarks of Sony Corporation.
- MICROVAULT is a trademark of Sony Corporation.
- Wi-Fi®, Wi-Fi Protected Access®, Wi-Fi Alliance® and Wi-Fi CERTIFIED Miracast® are registered trademarks of Wi-Fi Alliance®.
- Wi-Fi CERTIFIED™, WPA™, WPA2™, Wi-Fi Protected Setup™ and Miracast™ are trademarks of Wi-Fi Alliance®.
- The Wi-Fi CERTIFIED™ Logo is a certification mark of Wi-Fi Alliance®.
- MHL, Mobile High-Definition Link and the MHL Logo are trademarks or registered trademarks of MHL Licensing, LLC.
- The BLUETOOTH® word mark and logos are registered trademarks owned by Bluetooth SIG, Inc. and any use of such marks by Sony Corporation is under license. Other trademarks and trade names are those of their respective owners.
- The N Mark is a trademark or registered trademark of NFC Forum, Inc. in the United States and in other countries.
- Android™ is a trademark of Google Inc.
- Google Play™ is a trademark of Google Inc.
- Google Cast is a trademark of Google Inc.
- This product incorporates Spotify software which is subject to 3rd party licenses found

here:

<https://developer.spotify.com/esdk-third-party-licenses/>

- Spotify and Spotify logos are trademarks of the Spotify Group.
- All other trademarks and registered trademarks are of their respective holders. In this manual, ™ and ® marks are not specified.

This product contains software that is subject to the GNU General Public License (“GPL”) or GNU Lesser General Public License (“LGPL”).

These establish that customers have the right to acquire, modify, and redistribute the source code of said software in accordance with the terms of the GPL or the LGPL.

For details of the GPL, LGPL and other software licenses, please refer to [Software License Information] in [System Settings] of the [Setup] menu on the product.

The source code for the software used in this product is subject to the GPL and LGPL, and is available on the Web. To download, please access the following:

URL: <http://oss.sony.net/Products/Linux/>

Please note that Sony cannot answer or respond to any inquiries regarding the content of this source code.

How to connect speaker cables

Connect speaker cables as illustrated below.

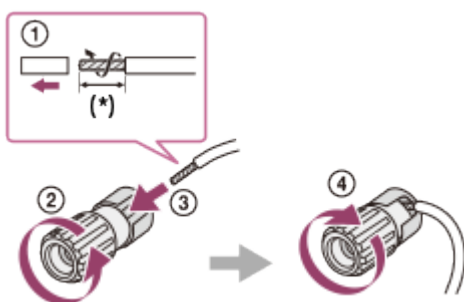

* Strip the jacket to 10 mm (13/32 in) at each end of the speaker cables.

Confirming active subwoofer setup

- When a subwoofer is connected, turn on the subwoofer and turn up the volume prior to activating the subwoofer. Turn the LEVEL to just before the mid-point.



- If you connect a subwoofer with a crossover frequency function, set the value to maximum.



- If you connect a subwoofer with an auto standby function, set it to off (deactivated). For details, refer to the operating instructions of the subwoofer.

Note

- Depending on the characteristics of the subwoofer you are using, the setup distance value may be different from the actual position.

Auto Format Direct (A.F.D.)/2-channel sound mode

- **Auto Format Direct (A.F.D.) mode:** This mode allows you to listen to higher-fidelity sound and select the decoding mode for listening to a 2-channel stereo or monaural sound as multi-channel sound.
- **2-channel sound mode:** You can switch the output sound to 2-channel sound regardless of the recording formats of the software you are using, the playback device connected, or the sound field settings of the receiver.

A.F.D./2CH: Auto Format Direct (A.F.D.):

Presets the sound as it was recorded/encoded without adding any surround effects.

However, for USA and Canada models, this receiver will generate a low-frequency signal for output to the subwoofer when there is no LFE signals.

Multi Stereo (MULTI ST.):

Outputs 2-channel left/right or monaural signals from all speakers. However, sound may not be output from certain speakers depending on the speaker settings.

2ch Stereo (2CH ST.):

The receiver outputs the sound from the front left/right speakers only. There is no sound from the subwoofer.

Standard 2-channel stereo sources completely bypass the sound field processing and multi-

channel surround formats are downmixed to 2-channels.

Analog Direct (A. DIRECT):

You can switch the audio of the selected input to 2-channel analog input. This function enables you to enjoy high-quality analog sources.

Only the volume and front speaker level can be adjusted when using this function.

Note

- You cannot select [Analog Direct] while using the BD/DVD, GAME, VIDEO 2, BLUETOOTH, USB, Home Network, Music Services, AirPlay or Screen mirroring function.
- [Multi Stereo] does not work when multi-channel audio signals are being received.
- Depending on the audio format, if you select [A.F.D./2CH: Auto Format Direct] and play a 5.1ch source when surround speakers and two surround back speakers are connected, the same audio as that from surround speakers will be output from surround back speakers, similar to that of a 7.1ch surround system. The sound level of surround and surround back speakers are adjusted automatically for optimum balance.

[Movie] mode

You can take advantage of surround sound simply by selecting one of the receiver's pre-programmed sound fields. They bring the exciting and powerful sound of movie theaters into your home.

HD-D.C.S.:

HD Digital Cinema Sound (HD-D.C.S.) is Sony's new innovative home theater technology using the latest acoustic and digital signal processing technologies. It is based on the precise response measurement data of a mastering studio.

With this mode, you can enjoy Blu-ray and DVD movies at home with not only a high-quality of sound but also the best sound ambience, just as the movie's sound engineer intended in the mastering process.

- **Dynamic:** This setting is suitable for an environment which is reverberant but lacks a spacious feel (where sound absorption is not sufficient). It emphasizes the reflection of sound and reproduces the sound of a large, classic movie theater. This emphasizes the spacious feel of a dubbing theater and creates a unique acoustic field.
- **Theater:** This setting is suitable for a general living room. It reproduces the reverberation of sound just like in a movie theater (dubbing theater). It is most appropriate for watching content recorded on a Blu-ray Disc when you want the atmosphere of a movie theater.
- **Studio:** This setting is suitable for a living room with the appropriate sound devices. It reproduces the reverberation of sound provided when a theatrical sound source is

remixed for a Blu-ray Disc to a volume level suitable for home use. The level of reflection and reverberation of sound is kept to a minimum, while dialogues and surround effects are reproduced vividly.

PLII Movie:

Performs Dolby Pro Logic II Movie mode decoding. This setting is ideal for movies encoded in Dolby Surround. In addition, this mode can reproduce sound in 5.1-channel format when watching videos of overdubbed or old movies.

PLIIX Movie:

Performs Dolby Pro Logic IIX Movie mode decoding. This setting expands Dolby Pro Logic II Movie or Dolby Digital 5.1 to 7.1 discrete movie channels.

Neo:6 Cinema (Neo:6 CIN):

Performs DTS Neo:6 Cinema mode decoding. Sources recorded in 2-channel format are enhanced up to 7 channels.

[Music] mode

You can take advantage of surround sound simply by selecting one of the receiver's pre-programmed sound fields. These bring the exciting and powerful sound of concert halls into your home.

Concert Hall A (HALL A):

Reproduces the acoustics of a vineyard style concert hall in Berlin famous for its clear acoustics.

Concert Hall B (HALL B):

Reproduces the acoustics of a shoe box style concert hall with plaster walls in Amsterdam.

Concert Hall C (HALL C):

Reproduces the acoustics of a wooden shoe box style concert hall in Vienna.

Jazz Club (JAZZ):

Reproduces the acoustics of a jazz club.

Live Concert (CONCERT):

Reproduces the acoustics of a 300-seat live house.

Stadium (STADIUM):

Reproduces the feel of a large open-air stadium.

Sports (SPORTS):

Reproduces the feel of sports broadcasting.

Portable Audio (PORTABLE):

Upscales existing sound sources to near hi-resolution sound quality with DSEE HX. This sound field makes you feel as if you are really at the recording studio or concert.

DSEE HX only works on 2-channel sound sources with a sampling frequency of 44.1 kHz or 48 kHz. However, it does not work during AirPlay playback.

PLII Music:

Performs Dolby Pro Logic II Music mode decoding. This setting is ideal for normal stereo sources such as CDs.

PLIIX Music:

Performs Dolby Pro Logic IIX Music mode decoding. This setting is ideal for normal stereo sources such as CDs.

Neo:6 Music (Neo:6 MUS):

Performs DTS Neo:6 Music mode decoding. Sources recorded in 2-channel format are enhanced up to 7 channels. This setting is ideal for normal stereo sources such as CDs.

When listening with headphones

You can only select this sound field if headphones are connected to the receiver.

Headphone(2ch) (HP 2CH):

This mode is selected automatically if you use headphones (except when [Analog Direct] is selected). Standard 2-channel stereo sources completely bypass the sound field processing and multi-channel surround formats are downmixed to 2 channels except LFE signals.

Headphone(Direct) (HP DIRECT):

This mode is selected automatically if you use headphones when [Analog Direct] is selected. This mode outputs analog signals without processing by the equalizer, sound field, etc.

Checking the information of a connected BLUETOOTH device

You can check the BLUETOOTH device information by pressing DISPLAY MODE on the receiver repeatedly.

Each time you press DISPLAY MODE, the display will change cyclically as follows:

BLUETOOTH device name - Sound field currently applied - Volume level - Input you selected

Menu list (on the display panel)

The following options are available in each menu.

Auto Calibration settings [<AUTO CAL>]

- **Auto Calibration start [A.CAL START]**
- **Auto Calibration type [CAL TYPE] (*1)**
FULL FLAT, ENGINEER, FRONT REF, OFF
- **Automatic Phase Matching [A.P.M.] (*1)**
A.P.M. AUTO, A.P.M. OFF

Level settings [<LEVEL>]

- **Test Tone [TEST TONE] (*2)**
OFF, AUTO XXX (*3), FIX XXX (*3)
- **Test Tone Phase Noise [P. NOISE] (*2)**
OFF, FL/FR, FL/CNT, CNT/FR, FR/SR, SR/SBR, SR/SB, SBR/SBL, SR/SL, SBL/SL, SB/SL, SL/FL, LH/RH, FL/SR, SL/FR, FL/RH, LH/FR
- **Test Tone Phase Audio [P. AUDIO] (*2)**
OFF, FL/FR, FL/CNT, CNT/FR, FR/SR, SR/SBR, SR/SB, SBR/SBL, SR/SL, SBL/SL, SB/SL, SL/FL, LH/RH, FL/SR, SL/FR, FL/RH, LH/FR
- **Front left speaker level [FL LEVEL] (*2)**
FL -10.0 dB to FL +10.0 dB (0.5 dB interval)
- **Front right speaker level [FR LEVEL] (*2)**
FR -10.0 dB to FR +10.0 dB (0.5 dB interval)
- **Center speaker level [CNT LEVEL] (*2)**
CNT -10.0 dB to CNT +10.0 dB (0.5 dB interval)
- **Surround left speaker level [SL LEVEL] (*2)**
SL -10.0 dB to SL +10.0 dB (0.5 dB interval)
- **Surround right speaker level [SR LEVEL] (*2)**
SR -10.0 dB to SR +10.0 dB (0.5 dB interval)
- **Surround back speaker level [SB LEVEL] (*2)**
SB -10.0 dB to SB +10.0 dB (0.5 dB interval)
- **Surround back left speaker level [SBL LEVEL] (*2)**
SBL -10.0 dB to SBL +10.0 dB (0.5 dB interval)
- **Surround back right speaker level [SBR LEVEL] (*2)**
SBR -10.0 dB to SBR +10.0 dB (0.5 dB interval)
- **Front left high speaker level [LH LEVEL] (*2)**

- LH -10.0 dB to LH +10.0 dB (0.5 dB interval)
- **Front right high speaker level [RH LEVEL] (*2)**
RH -10.0 dB to RH +10.0 dB (0.5 dB interval)
- **Subwoofer Level [SW LEVEL] (*2)**
SW -10.0 dB to SW +10.0 dB (0.5 dB interval)

Speaker settings [<SPEAKER>]

- **Speaker pattern [SP PATTERN]**
5/2.1 to 2/0 (20 patterns)
- **In-ceiling Speaker Height [CEILING H.]**
2.00 m to 10.00 m (6'6" to 32'9") (0.01 m (1 inch) interval)
- **Center Speaker Lift Up [CNT LIFT] (*4)**
LIFT 1 to LIFT 10, LIFT OFF
- **Front speakers size [FRT SIZE] (*2)**
LARGE, SMALL
- **Center speaker size [CNT SIZE] (*2)**
LARGE, SMALL
- **Surround speakers size [SUR SIZE] (*2)**
LARGE, SMALL
- **Front high speakers size [FH SIZE] (*2)**
LARGE, SMALL
- **Surround Speaker Assign [SUR ASSIGN] (*5) (for STR-DN1060 only)**
OFF, ZONE3
- **Surround back speaker assign [SB ASSIGN] (*6)**
SPK B, ZONE2 (for STR-DN1060 only), BI-AMP, OFF
- **Front left speaker distance [FL DIST.] (*2)**
FL 1.00 m to FL 10.00 m (FL 3'3" to FL 32'9") (0.01 m (1 inch) interval)
- **Front right speaker distance [FR DIST.] (*2)**
FR 1.00 m to FR 10.00 m (FR 3'3" to FR 32'9") (0.01 m (1 inch) interval)
- **Center speaker distance [CNT DIST.] (*2)**
CNT 1.00 m to CNT 10.00 m (CNT 3'3" to CNT 32'9") (0.01 m (1 inch) interval)
- **Surround left speaker distance [SL DIST.] (*2)**
SL 1.00 m to SL 10.00 m (SL 3'3" to SL 32'9") (0.01 m (1 inch) interval)
- **Surround right speaker distance [SR DIST.] (*2)**
SR 1.00 m to SR 10.00 m (SR 3'3" to SR 32'9") (0.01 m (1 inch) interval)
- **Surround back speaker distance [SB DIST.] (*2)**
SB 1.00 m to SB 10.00 m (SB 3'3" to SB 32'9") (0.01 m (1 inch) interval)
- **Surround back left speaker distance [SBL DIST.] (*2)**
SBL 1.00 m to SBL 10.00 m (SBL 3'3" to SBL 32'9") (0.01 m (1 inch) interval)
- **Surround back right speaker distance [SBR DIST.] (*2)**
SBR 1.00 m to SBR 10.00 m (SBR 3'3" to SBR 32'9") (0.01 m (1 inch) interval)
- **Front left high speaker distance [LH DIST.] (*2)**
LH 1.00 m to LH 10.00 m (LH 3'3" to LH 32'9") (0.01 m (1 inch) interval)

Front right high speaker distance [RH DIST.] (*2)

RH 1.00 m to RH 10.00 m (RH 3'3" to RH 32'9") (0.01 m (1 inch) interval)

- **Subwoofer distance[SW DIST.] (*2)**

SW 1.00 m to SW 10.00 m (SW 3'3" to SW 32'9") (0.01 m (1 inch) interval)

- **Distance Unit [DIST. UNIT]**

METER, FEET

- **Front speakers crossover frequency [FRT CROSS] (*7)**

CROSS 40 Hz to CROSS 200 Hz (10 Hz interval)

- **Center speaker crossover frequency [CNT CROSS] (*7)**

CROSS 40 Hz to CROSS 200 Hz (10 Hz interval)

- **Surround speakers crossover frequency [SUR CROSS] (*7)**

CROSS 40 Hz to CROSS 200 Hz (10 Hz interval)

- **Front high speakers crossover frequency [FH CROSS] (*7)**

CROSS 40 Hz to CROSS 200 Hz (10 Hz interval)

Input settings [<INPUT>]

- **Input Mode [INPUT MODE]**

AUTO, OPT, COAX, ANALOG

- **Naming inputs [NAME IN]**

For details, see "[Changing the name for each input \(Name\).](#)" in Input Settings menu.

- **Digital audio input assignment [A. ASSIGN]**

OPT 1, OPT 2, COAX, NONE

- **Component video input assignment [V. ASSIGN] (for STR-DN1060 only)**

COMP, NONE

Surround settings [<SURROUND>]

- **HD-D.C.S. effect type [HD-D.C.S. TYP] (*8)**

DYNAMIC, THEATER, STUDIO

EQ settings [<EQ>]

- **Front speakers bass level [FRT BASS]**

FRT B. -10 dB to FRT B. +10 dB (1 dB interval)

- **Front speakers treble level [FRT TREBLE]**

FRT T. -10 dB to FRT T. +10 dB (1 dB interval)

- **Center speaker bass level [CNT BASS]**

CNT B. -10 dB to CNT B. +10 dB (1 dB interval)

- **Center speaker treble level [CNT TREBLE]**

CNT T. -10 dB to CNT T. +10 dB (1 dB interval)

- **Surround speakers bass level [SUR BASS]**

SUR B. -10 dB to SUR B. +10 dB (1 dB interval)

- **Surround speakers treble level [SUR TREBLE]**

SUR T. -10 dB to SUR T. +10 dB (1 dB interval)

- **Front high speakers bass level [FH BASS]**

FH B. -10 dB to FH B. +10 dB (1 dB interval)

- **Front high speakers treble level [FH TREBLE]**

FH T. -10 dB to FH T. +10 dB (1 dB interval)

Zone settings [<ZONE>] (for STR-DN1060 only)

- **Zone 2 lineout [Z2 LINEOUT]**

FIXED, VARIABLE

Tuner settings [<TUNER>]

- **FM station receiving mode [FM MODE]**

STEREO, MONO

- **Naming preset stations [NAME IN]**

For details, see “[Naming preset stations \(Name Input\).](#)”

Audio settings [<AUDIO>]

- **In-Ceiling Speaker Mode [IN-CEILING]**

MODE ON, MODE OFF

- **Digital Legato Linear [D.L.L.]**

D.L.L. AUTO2, D.L.L. AUTO1, D.L.L. OFF

- **Sound Optimizer [OPTIMIZER]**

NORMAL, LOW, OFF

- **LFE Time Alignment [LFE TIME]**

0 ms to 20 ms (0.5 ms interval)

- **Synchronizes audio with video output [A/V SYNC]**

HDMI AUTO, 0 ms to 300 ms (10 ms interval)

- **Advanced Auto Volume [AUTO VOL]**

A. VOL ON, A. VOL OFF

- **Subwoofer Low Pass Filter [SW L.P.F.]**

L.P.F. ON, L.P.F. OFF

- **Digital broadcast language selection [DUAL MONO]**

MAIN/SUB, MAIN, SUB

- **Dynamic Range Compressor [D. RANGE]**

COMP. ON, COMP. AUTO, COMP. OFF

HDMI settings [<HDMI>]

- **HDMI In 4K Scaling [4K SCALING]**

AUTO, OFF

- **Control for HDMI [CTRL: HDMI]**

CTRL ON, CTRL OFF

- **Standby Through [STBY THRU]**

ON, AUTO, OFF

- **HDMI Out B Mode [OUTB MODE] (for STR-DN1060 only)**

MAIN, ZONE

- **Priority [PRIORITY]**
MAIN&ZONE, MAIN ONLY
- **HDMI Audio Out [AUDIO OUT]**
AMP, TV+AMP
- **HDMI Subwoofer Level [SW LEVEL]**
SW AUTO, SW +10 dB, SW 0 dB
- **Fast View [FAST VIEW]**
AUTO, OFF
- **MHL Auto Input [MHL.AUTO IN]**
ON, OFF

BLUETOOTH settings [<BT>]

- **BLUETOOTH Mode [BT MODE] (*9)**
RECEIVE, TRANSMIT, OFF
- **BLUETOOTH AAC [BT AAC] (*10)**
AAC ON, AAC OFF
- **BLUETOOTH LDAC [BT LDAC] (*10)**
LDAC ON, LDAC OFF
- **Wireless Playback Quality [QUALITY] (*11)**
AUTO, SOUND, STANDARD, CONNECTION
- **BLUETOOTH Standby [BT STANDBY] (*10)**
STBY ON, STBY OFF

System settings [<SYSTEM>]

- **Remote Start [RM START]**
ON, OFF
- **Auto standby mode [AUTO STBY]**
STBY ON, STBY OFF
- **Quick Start/Network Standby [QUICK.START] (for USA, Canadian and Asia-Pacific models only)**
MODE ON, MODE OFF
- **Version display [VERSION] (*12)**
XXX.X.XXXX
- **Sleep timer [SLEEP]**
OFF - 0:30:00 - 1:00:00 - 1:30:00 - 2:00:00

*1 You can select this setting only when you have performed Auto Calibration and saved the settings.

*2 Some parameters or settings may not be available depending on the speaker pattern setting.

*3 XXX represents a speaker channel (FL, FR, CNT, SL, SR, SB, SBL, SBR, LH, RH, SW).

*4 You can only select this parameter if [SP PATTERN] is set to a pattern with front high speakers. (i.e. 5/2.1, 5/2, 4/2.1, 4/2)

*5 You can only select this parameter if [SP PATTERN] is not set to a pattern with surround

speakers. (i.e. 3/0.1, 3/0, 2/0.1, 2/0)

*⁶ You can only select this parameter if [SP PATTERN] is not set to a pattern with surround back and front high speakers. (i.e. 3/2.1, 3/2, 2/2.1, 2/2, 3/0.1, 3/0, 2/0.1, 2/0)

*⁷ You can only select this parameter if the speaker is set to [SMALL].

*⁸ You can only select this parameter if you select [HD-D.C.S.] as the sound field.

*⁹ You cannot select this parameter when [Bluetooth] or [Screen mirroring] function is selected.

*¹⁰ You cannot select this parameter when [Bluetooth Mode] is set to [Off].

*¹¹ You can only select this parameter when [Bluetooth Mode] is set to [Transmitter] and [Bluetooth Codec - LDAC] is set to [On].

*¹² XXXX represents the version number.

Formats compatible with home networks

Supported music formats (*1)

MP3 (MPEG 1 Audio Layer-3):

.mp3

AAC/HE-AAC (*2):

.m4a

WMA9 Standard (*2):

.wma

LPCM:

.wav

FLAC (*2):

.flac, .fla

DSF (*2):

.dsf

DSDIFF (*2)(*3):

.dff

AIFF (*2):

.aiff, .aif

ALAC (*2):

.m4a

Supported photo formats

JPEG:

.jpeg, .jpg, .jpe

PNG (*4):

.png

GIF (*4):

.gif

*1 Compatibility with all encoding/writing software, recording devices and recording media cannot be guaranteed.

*2 The receiver may not play this file format on a Home Network server.

*3 The receiver does not play DST encoded files.

*4 The receiver does not play animated PNG or animated GIF files.

Note

- Some files may not play depending on the file format, the file encoding, the recording condition, or Home Network server condition.
- Some files that have been edited on a PC may not play.
- Fast forward or fast reverse functions may not be available for some files.
- The receiver does not play 3D photo files.
- The receiver does not play coded files such as DRM and Lossless.
- The receiver can recognize the following files or folders stored in the Home Network server:
 - up to folders in the 19th layer
 - up to 999 files/folders in a single layer

Adjusting the balance between adjacent speakers by outputting a test tone (Phase Noise)

You can output a test tone from adjacent speakers to adjust the balance between the speakers.

This operation is only available using the display panel on the front of the receiver.

1. Press AMP MENU.
The menu is displayed on the display panel of the receiver.
2. Select [<LEVEL>] (Level settings) - [P. NOISE].
3. Select the speakers to output the test tone from.
The test tone is output from the selected speakers.

4. Adjust the speaker level using MASTER VOLUME on the receiver.

Available speakers:

FL/FR (Front Left/Front Right)
FL/CNT (Front Left/Center)
CNT/FR (Center/Front Right)
FR/SR (Front Right/Surround Right)
SR/SBR (Surround Right/Surround Back Right)
SR/SB (Surround Right/Surround Back)
SBR/SBL (Surround Back Right/Surround Back Left)
SR/SL (Surround Right/Surround Left)
SBL/SL (Surround Back Left/Surround Left)
SB/SL (Surround Back/Surround Left)
SL/FL (Surround Left/Front Left)
LH/RH (Left Front High/Right Front High)
FL/SR (Front Left/Surround Right)
SL/FR (Surround Left/Front Right)
FL/RH (Front Left/Right Front High)
LH/FR (Left Front High/Front Right)

Note

- Some items may not appear, depending on the connected speakers.
- This function is canceled if you perform any operation other than the following:
 - Volume adjustment
 - Level adjustment of each speaker
 - Turning the muting function on/off
- This function is not available when [Bluetooth Mode] is set to [Transmitter].

Hint

- Select [OFF] in step 3 to disable the Phase Noise function.

Adjusting the balance between adjacent speakers by outputting a source sound (Phase Audio)

You can output the source sound from adjacent speakers to adjust the balance between the speakers.

This operation is only available using the display panel on the front of the receiver.

1. Press AMP MENU.

The menu is displayed on the display panel of the receiver.

2. Select [<LEVEL>] (Level settings) - [P. AUDIO].

3. Select the speakers to output the sound from.

The front 2 channel source sound is output sequentially from adjacent speakers.

4. Adjust the speaker level using MASTER VOLUME on the receiver.

Available speakers:

FL/FR (Front Left/Front Right)

FL/CNT (Front Left/Center)

CNT/FR (Center/Front Right)

FR/SR (Front Right/Surround Right)

SR/SBR (Surround Right/Surround Back Right)

SR/SB (Surround Right/Surround Back)

SBR/SBL (Surround Back Right/Surround Back Left)

SR/SL (Surround Right/Surround Left)

SBL/SL (Surround Back Left/Surround Left)

SB/SL (Surround Back/Surround Left)

SL/FL (Surround Left/Front Left)

LH/RH (Left Front High/Right Front High)

FL/SR (Front Left/Surround Right)

SL/FR (Surround Left/Front Right)

FL/RH (Front Left/Right Front High)

LH/FR (Left Front High/Front Right)

Note

- Some items may not appear, depending on the connected speakers.
- This function is canceled if you perform any operation other than the following:
 - Volume adjustment
 - Level adjustment of each speaker
 - Turning the muting function on/off
- This function is not available when [Bluetooth Mode] is set to [Transmitter].

Hint

- Select [OFF] in step 3 to disable the Phase Audio function.